

## GO BEYOND!

Who we are: passionate innovators pushing the boundaries of what is possible. What we do: combine leading-edge engineering with innovative materials to create movement. What makes us proud: having our ultralight wheelchairs echo the love of life their users demonstrate each day. Through our unique approach and distinct attitude, our aim is to enhance lives, nourish a sense of freedom and revolutionize the way people see wheelchairs.

**LEARN MORE** To learn more about the APEX C and find more information regarding our products, visit our website at [motioncomposites.com](https://motioncomposites.com)



T 1 (866) 650-6555

F 1 (888) 966-6555

[motioncomposites.com](https://motioncomposites.com)

0070688B-00-v6-APEX CARBON BROCHURE - ENGLISH-08-03-23



RIGID  
CARBON

APEX C

LIVE BOLDLY WITHOUT LIMITS



## LIVE BOLDLY WITHOUT LIMITS

The APEX Carbon wheelchair by Motion Composites is leading a new era of rigid wheelchairs. A balanced blend of technology and design, it is the ultimate in lightness, durability, flexibility and style. Motion Composites was created from the desire to improve the wheelchair industry by taking advantage of carbon fiber's excellent physical attributes. The APEX with its bold, high-end manufacturing offers all the advantages of this material in a slick, fully adjustable chair that becomes a true extension of the user's drive.

World-renowned, Motion Composites uses its know-how and its passion for innovation to design unique, cutting-edge products inspired by you. As a visionary and passionate company, our ambition is driven by your experience.

We believe that high-performance wheelchairs enhance people's lives with components, design, features and quality. APEX Carbon is our passion for performance, our commitment to quality and our vision of greater freedom brought to life.

GO BEYOND!



reddot award 2017  
winner



Model/Ambassador: Woody Belfort



“With the Motion Composites APEX chair, I feel lighter than ever.”

– Saoud Messaoudi, Quebec, Canada

## ULTRALIGHT AND COMFORTABLE

- 9.8 lb. — A lightness that shapes the future of lightweight rigid wheelchairs
- Stable and comfortable handling

Made of the industry's most advanced materials, the APEX Carbon wheelchair is truly state-of-the-art. Manufactured with the highest quality standards, the frame is designed using carbon fiber layers making it incredibly light. Its cantilever design provides optimal comfort by absorbing shocks and vibrations. Agile transportation and movement enable better quality of life and help to go beyond expectations!

## AGILE AND HIGH-PERFORMANCE

- Optimized handling
- Uncompromising stability

Experience impressive, responsive and safe handling thanks to a strong, lightweight carbon frame and unparalleled design. The rigidizing bar unique to the APEX model maximizes stability while preserving reactivity. This sturdiness reduces lateral movement and offers optimal propulsion for greater mobility.

## ADJUSTABLE AND FLEXIBLE

- Infinitely adjustable
- Adapts to your lifestyle

The APEX Carbon wheelchair offers a number of settings for a completely customized experience. Fully modular, the back angle, seat-to-floor height and rear wheel positions can all be adjusted for your comfort. Laser-etched markings make it easier to adjust key components and specify exact positioning. Simple. Quick. Adaptive.

## STURDY AND DURABLE

- The industry's most perfected materials
- Uncompromising reliability

Carbon fiber has the quality of being one of the strongest, yet one of the lightest materials on earth. It also has superior fatigue resistance meaning that it will resist the repetitive stress of everyday use longer. The four rigidizers also made of carbon allow for optimal propulsion and frame stiffness. The APEX Carbon ensures exceptional durability that will serve you for many years to come.

## DESIGN AND STYLE

- Bold, modern and refined design
- Attention to detail and aesthetics

While technology and function are important, so are design and aesthetics. From the aggressive styling of the angled front end and understated elegance of the color badging, each stylish element was carefully crafted. The APEX Carbon presents the head-turning lines and the bold design to instill a sense of pride.

## FEATURES

### CANTELIVER FRAME

Frame assembled by a precision fixing system offering exceptional rigidity and maximizing efficiency while allowing adjustments

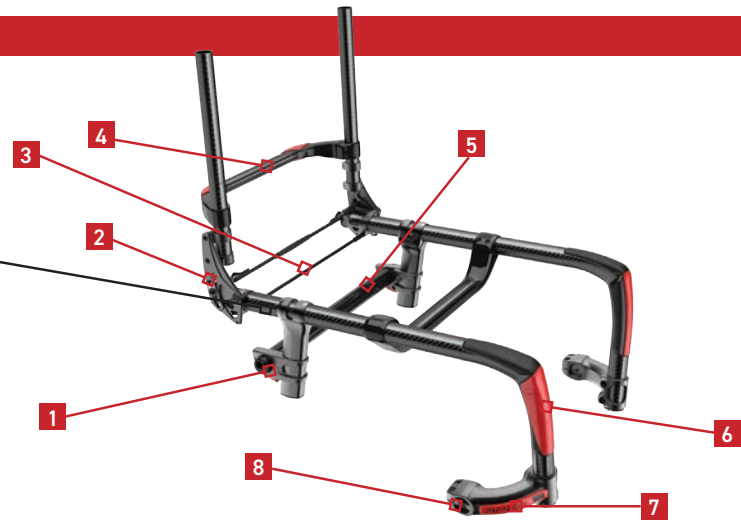

#### 1 REAR AXLE PLATE

Provides a multitude of adjustments while maximizing stability and responsiveness



#### 2 BACK REST ADJUSTMENT

Offers wide range of adjustments to fit any position



#### 3 STANDARD CARBON FIBER REAR RIGIDIZER BAR

Allows for optimal propulsion and frame stiffness



#### 4 CARBON RIGIDIZER BAR WITH REFLECTORS

Maintains strength and durability through the life of the chair



#### 5 STANDARD CARBON FIBER CAMBER TUBE

Adds carbon fiber strength and reduces overall weight

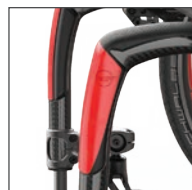

#### 6 INTEGRATED IMPACT GUARD

Prevents daily-use scratches and protects lower extremities



#### 7 FRONT BUMPER

Provides style and protection



#### 8 BUBBLE LEVELS

Highly accurate and calibrated system for a quick and perfect adjustment

## TECHNICAL SPECIFICATIONS

FRAME	Rigid	WIDTH	12 in. to 20 in.   30.5 cm to 50.8 cm
MATERIAL	T700 High-tensile strength carbon fiber	DEPTH	12 in. to 20 in.   30.5 cm to 50.8 cm
TRANSPORT WEIGHT	9.7 lb.   4.4 kg (16 x 16 with rear wheels, wheel locks, armrests, cushion and anti-tippers)	FRONT SEAT-TO-FLOOR HEIGHT	14 in. to 21 in.   35.6 cm to 53.3 cm (with 3 in. to 6 in. caster)
LIGHTEST CONFIGURATION	17.2 lb.   7.8 kg, with wheel locks and wheels	REAR SEAT-TO-FLOOR HEIGHT	14 in. to 20 in.   35.6 cm to 50.8 cm (with 20 in. to 26 in. wheel)
WEIGHT LIMIT	265 lb.   120 kg		

## TECHNOLOGIES



### T700 HIGH-TENSILE STRENGTH CARBON FIBER

One of the lightest and sturdiest material available, also renowned for its vibration damping properties.



### INTEGRATED IMPACT GUARD WITH TOP GRIP

Prevents daily-use scratches to the front of the frame. Adds high friction grip for transfers. Protects vulnerable areas of lower extremities.



### CLAMPED RIGIDIZING SYSTEM

Patented modular system that enhances versatility and rear frame stiffness.



### BUBBLE LEVELS

Built-in highly accurate and calibrated gauges make caster adjustments quick and precise.



### STANDARD CARBON FIBER CAMBER TUBE

Provides a responsive ride without added weight.



### LASER ETCHED MARKINGS

Allow for quick and easy symmetrical adjustments.



### NEWTON ACCESSORIES

Parts and accessories designed to be lighter with improved functionality.

## COLOR CHART – COLORS ARE ON PROTECTORS



Black



Sunkissed Orange



Fuchsia



Ferrari Red



Acid Green



White



Sky Blue

## FRAME COLOR – CROSS BRACE IS BLACK

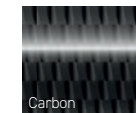

Carbon

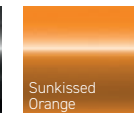

Sunkissed Orange

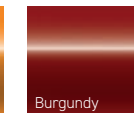

Burgundy



Sapphire Blue



Monster Green



Charcoal

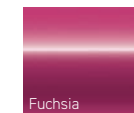

Fuchsia



Steel Blue



Ferrari Red

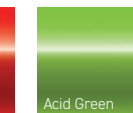

Acid Green



Electric Purple



Caribbean Blue

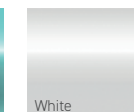

White

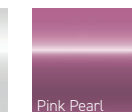

Pink Pearl



Plum Purple



Sky Blue

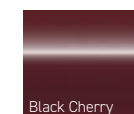

Black Cherry



Khaki Green (Matte Finish)



Desert Sand (Matte Finish)

## DIMENSIONS



**SEAT WIDTH**  
12 in. to 20 in. |  
30.5 cm to 50.8 cm



**SEAT DEPTH**  
12 in. to 20 in. |  
30.5 cm to 50.8 cm



**FRONT SEAT-TO-FLOOR HEIGHT**  
14 in. to 21 in. |  
35.6 cm to 53.3 cm



**REAR SEAT-TO-FLOOR HEIGHT**  
14 in. to 20 in. |  
35.6 cm to 50.8 cm



**WHEEL CAMBER**  
0°, 2°, 4°, 6°, 8°



**BACK HEIGHT**  
9 in. to 21 in. |  
22.9 cm to 53.3 cm



**ARMREST HEIGHT**  
6 in. to 14 in. |  
15.2 cm to 35.6 cm



**FRONT FRAME ANGLE**  
70°, 75°, 80°, 85°, 90°



**BACK ANGLE**  
80° to 101°



**CENTER OF GRAVITY**  
0 in. to 6 in. |  
0 cm to 15.2 cm



**OVERALL WIDTH**  
18½ in. min. to 31½ in. max.  
47.6 cm min. to 80 cm max.



**WEIGHT LIMIT**  
265 lb. | 120 kg