

Defining Patient Handling for Over 70 Years





Table of Contents

THE HOYER DIFFERENCE	4
Hoyer Familial Features	
Mobility Assessment & Lift Selection	
FLOOR LIFTS	9
Stature	
Presence	
Advance	
Calibre	
HPL500	
HPL700	
HPL402	
HML400	
STAND-AID LIFTS	19
Elevate	
Journey	
HSA Series	
Switch	
CEILING LIFTS	25
Elara	
Ceiling & Installation Services	
Voyager	
Portable Easytrack	
FreeStanding Easytrack	
SLINGS & ACCESSORIES	33
About Hoyer Slings	
Passive / Ceiling Lift Slings	
Active Slings	
Spreader Bar & Cradles	
Accessories	
PREVENT PROGRAM	49
ABOUT JOERNS HEALTHCARE	51

THE HOYER DIFFERENCE

Why is Hoyer® most recognized of patient lifts and slings?

At Joerns Healthcare, the manufacturer of Hoyer products, we are committed to providing a complete line of top quality equipment and programs to the care continuum.



HOYER LIFTS CREATE THE STANDARD WHEN IT COMES TO USABILITY.

The direct correlation between safe patient handling principles and Hoyer's lift design ensures our products are simple, comfortable and, above all, safe to use. Careful attention to product design ensures correct ergonomic usage, protecting both the patient and the caregiver from injury at all times.

Safe Patient Handling Guidelines

- Get up close to the load
- Use a wide stable base
- Ensure a comfortable firm grasp
- Keep spine close to neutral
- Make sure movement is smooth

SUPPORTED BY EXPERT-DELIVERED JOERNS PREVENT® SOLUTIONS AND DESIGNED TO DRIVE BEST PRACTICE AND COMPLIANCE

Prevent Program: Three Core Objectives

1. Integrate lifting policy and procedures
2. Education, training and mentoring
3. Improve outcomes and maximize ROI

Musculoskeletal disorders, specifically back injuries, have been an ongoing problem in the healthcare industry. Joerns Healthcare's certified safe patient handling experts will work with your facility(s) to design and implement a **Prevent Solution** customized to your needs.

Hoyer Familial Features*

STRAIGHT LINE DRIVE

Easy movement on long stretches

Stability minimizes damage to walls and doors during transport

Better movement in tight spaces



HOYER HANDLE (EXTRA WIDE AND TALL)

Large area provides caregivers the opportunity to position the lift more effectively for their comfort level

Protects electronic controls

Addresses comfortable grip aspect of safe patient handling principles

PUSH PAD

Addresses smooth movement of safe patient handling principles

Reduces lower back torque required for initial inertia

Endorsed by industry experts



BEST-IN-CLASS EFFECTIVE LIFTING RANGE**

Can work easily with the most critical of transfers

Minimum height ensures excellent off-the-floor transfers

Greater reach and spatial clearance

SMART MONITOR™

Displays and records vital lift utilization and service data

Drives usage compliance for Safe Patient Handling Programs

Service interval reminder helps prolong the life of the lift



*Familial features that may not be present on all lifts

**In-house study dated 2015

MOBILITY ASSESSMENT & LIFT SELECTION

This assessment is typically performed by a designated health professional or a team of health professionals. In addition, each patient will be assessed with regard to such factors as mental acuity, ability to comprehend instructions and cooperate in lifts and transfers, combativeness, weight, upper extremity strength, ability to bear weight, and specific medical conditions that may affect the selection of an appropriate means for lifting and transferring.

Patient Classification: This coding is consistent with activities of daily living (ADL) Self-Performance Codes for a patient's performance over all shifts during the last seven days.

<p>INDEPENDENT Another person is not required for the activity No Helper</p>	<p>0 – TOTALLY INDEPENDENT (FIM* 6-7) Can ambulate normally without assistance; in unusual situations may need some limited assistance. Help or oversight may have been provided only one or two times in the last seven days.</p>
<p>DEPENDENT Another person is required for either supervision or physical assistance in order for the activity to be performed Help Needed</p>	<p>1 – SUPERVISION (FIM 5) Can ambulate normally without assistance; in unusual situations may need some limited assistance. Help or oversight may have been provided only one or two times in the last seven days.</p> <p>2 – LIMITED ASSISTANCE (FIM 4) Highly involved in activity, able to pivot transfer, has considerable upper body strength, and bears some weight on legs. Can sit up well, but may need some assistance. Guided maneuvering of all limbs or other non-weight bearing assistance three or more times, or greater help provided one or two times during the last seven days.</p> <p>3 – EXTENSIVE ASSISTANCE (FIM 3) Can perform part of the activity, usually can follow simple directions, may require tactile cueing, can bear some weight, sit up with assistance, has some upper body strength, may be able to pivot transfer. Over the last seven day period, help provided three or more times for weight-bearing transfers or may have required a total transfer.</p>
<p>COMPLETE DEPENDENCE Maximal or total assistance is required, or the activity is not performed</p>	<p>4 – TOTAL DEPENDENT (FIM 1-2) Cannot help at all with transfers; full staff assistance for activity during entire seven day period. Requires total transfer at all times.</p>

By looking at the broad categories “dependent” (FIM scores 3, 4, and 5) and “complete dependence” (FIM scores 1 and 2), the FIM can assist in equipment needs identification, remembering that this tool is not designed for person-specific risk assessment.

MOBILITY ASSESSMENT & LIFT SELECTION

The table below indicates the type of equipment that may be appropriate in respect to each broad dependency category of a patient/person in order to ensure that safer handling practices can be facilitated. A person-specific risk assessment must be carried out in respect of those who require any assistance with movement/mobility.

Dependency Status	Floor or Overhead Lift (Passive)	Stand Aid Lift (Active)
INDEPENDENT	Unlikely to be required except in retrieval after fall or collapse	Unlikely to be required
DEPENDENT	May be required	Must be available
COMPLETE DEPENDENCE	Must be available	Unlikely to be required



Please Note: Staff in ALL areas must have immediate access to at least one mobile passive lift for use in the event of an emergency such as the retrieval of a patient who has fallen. A passive lift suitable for a very heavy person should also be accessible within the facility, and all staff should be aware of the system for accessing the lift as required. (For example, in the event of an unplanned admission of a very heavy patient).



Floor Lifts



STATURE



PRESENCE



ADVANCE



CALIBRE



HPL500



HPL700



HPL402



HML400



Bringing the Benefits of Vertical Lifting Closer to the Patient

The Stature® vertical lift recognizes the true needs of the modern care environment. With an extensive lifting range and a choice of either loop or clip sling configurations, the Stature can cope with even the most demanding and technical of patient handling requirements.

POWERED CRADLE & SPREADER BAR OPTIONS



A powered positioning cradle is available to assist with patient repositioning as well as a standard loop-style spreader bar for use with loop style slings.

SCALE OPTION



Easy to use with intuitive controls, the digital scale is ideal for patient monitoring. Importantly, it does not compromise lifting height.

POWERED LEG ADJUSTMENT



The powered leg adjustment allows the caregiver to open and close the legs without bending, twisting or use of force.

STRETCHER OPTION



Canvas stretcher can be used in combination with the 6-point stretcher adjustment cradle to facilitate horizontal transfers.

EFFECTIVE LIFTING RANGE (ELR)



It's designed to reach further across today's wide beds for safety and stability.



SAFE WORKING LOAD: 500 LB / 227 KG

SPECIFICATION		
Maximum Overall Length	54.7"	1390 mm
Minimum Overall Length	50.8"	1290 mm
Maximum Overall Height	83.8"	2130 mm
Minimum Overall Height	76.6"	1945 mm
Legs Open - External Width	53.5"	1360 mm
Legs Open - Internal Width	25.1"	1230 mm
Legs Closed - External Width	29.9"	760 mm
Legs Closed - Internal Width	25.1"	640 mm

WEIGHTS		
Mast, Base and Boom Assembly	142 lb	64.5 kg
Power Pack	6.6 lb	3 kg
Total	162 lb	73.5 kg
4-Point Positioning Cradle (manual)	13.2 lb	6 kg
4-Point Positioning Cradle (powered)	19.8 lb	9 kg

Specifications may vary due to manufacturing tolerances.

Lightweight with a Best-in-Class Feature Set that Helps Drive Compliance

The robust and reliable Presence® lift is designed to handle almost any patient handling task. Its extensive lifting range enables off-the-floor transfers to high bed frame surfaces. With an impressive safe working load and numerous options to match its environment, the Presence lift is a truly flexible, all-round performer.

LOW LEG OPTION



Low leg version offers half the standard leg height for improved access under low bed frames and other furniture.

INTERCHANGEABLE CRADLE OPTIONS



Optional manual or powered cradles provides the caregiver with a wider choice of sling systems and effortless re-positioning.

SCALE OPTION



Easy to use with intuitive controls, the digital scale is NAWI Class III rated and ideal for patient monitoring. Importantly, it does not compromise lifting height.

POWERED LEG ADJUSTMENT



Powered leg adjustment allows the caregiver to open and close the legs without bending, twisting or use of force.

STRETCHER OPTION



Canvas stretcher can be used in combination with the 6-point stretcher adjustment cradle to facilitate horizontal transfers.



SAFE WORKING LOAD: 500 LB / 227 KG



HOYER SMART MONITOR

- ◊ Lift Cycle Counter
- ◊ Overload Protection
- ◊ Service Reminder
- ◊ Emergency

SPECIFICATION

Maximum Overall Length	57.5"	1460 mm
Minimum Overall Length	55.1"	1400 mm
Maximum Overall Height	81.3"	2065 mm
Minimum Overall Height	57.5"	1460 mm
Legs Open - External Width	45.3"	1150 mm
Legs Open - Internal Width	40.1"	1020 mm
Legs Closed - External Width	26.4"	670 mm
Legs Closed - Internal Width	21.7"	550 mm

WEIGHTS

Mast, Base and Boom Assembly	81.6 lb	37 kg
Power Pack	6.6 lb	3 kg
Total	88.2 lb	40 kg
Base Assembly	44.4 lb	20 kg
Mast & Boom Assembly (no battery)	37.5 lb	17 kg

Specifications may vary due to manufacturing tolerances.



Compact and Portable Folding Lift, When Space is at a Premium

The Advance® is a compact folding lift that can perform an outstanding range of transfers. Whether from the floor or onto a bed, the Advance copes with ease. Its unique triangular design also enables it to be folded for easy storage and transportation.



TRIANGULAR FOLDING DESIGN



Folding design requires no tools and allows the lift to stand unassisted when stored. It is also possible to transport the Advance in its folded configuration.

ERGONOMIC PUSH HANDLE



Large contoured handle promotes easier maneuverability and also provides protection for the control system from incidental damage.

ANGLED LEG DESIGN



Angled leg design provides stability while closed to navigate the room yet enables the widest possible opening to get closer to large chairs, bulky commodes, and wheelchairs.

TRANSPORTATION TRANSFERS



It is also possible to transport the Advance in its folded configuration making it great for transfers from car or van.



SAFE WORKING LOAD: 342 LB / 155 KG



HOYER SMART MONITOR

- ◊ Lift Cycle Counter
- ◊ Overload Protection
- ◊ Service Reminder
- ◊ Emergency

SPECIFICATION

Maximum Overall Length	51.2"	1300 mm
Minimum Overall Length	49.2"	1250 mm
Maximum Overall Height	73.2"	1860 mm
Minimum Overall Height	53.5"	1360 mm
Legs Open - External Width	42.5"	1080 mm
Legs Open - Internal Width	39.4"	1000 mm
Legs Closed - External Width	26.4"	670 mm
Legs Closed - Internal Width	22.4"	570 mm

WEIGHTS

Mast, Base and Boom Assembly	63.7 lb	28.9 kg
Power Pack	6.2 lb	2.8 kg
Total	69.7 lb	31.7 kg
Base Assembly	32.8 lb	14.9 kg
Mast & Boom Assembly (no battery)	30.9 lb	14 kg

Specifications may vary due to manufacturing tolerances.

Bariatric Feature Set Developed with the Caregiver in Mind

The Calibre® is an ergonomically designed mobile patient lift for the safe lifting and handling of bariatric patients. Sturdy with a wealth of features that accommodate the custom needs of both the patient and care team, the Calibre, with an impressive safe working load of 850lb / 385 kg, meets the unique demands of the bariatric care environment.

WIDE PUSH HANDLE



The multi-point, right-sized push handle allows more than one caregiver to operate the lift, helping to avoid unnecessary strain and the potential for injury.

6-POINT POSITIONING CRADLE



The large, open cradle ensures greater spatial area and improved comfort for the patient. Great for working with patients of all sizes.

INTEGRATED SCALE



The Calibre is supplied with a low-profile digital, NAWI Class III scale. Easy-to-use with intuitive controls, the digital scale is ideal for patient monitoring.

POWERED LEG ADJUSTMENT



Powered leg adjustment allows the caregiver to open and close the legs without bending, twisting or using force.

TWIN FRONT CASTERS



Twin pivoting front casters are designed to give additional stability and maneuverability over uneven floor surfaces and room thresholds.



SAFE WORKING LOAD: 850 LB / 385 KG



HOYER SMART MONITOR

- Lift Cycle Counter
- Overload Protection
- Service Reminder
- Emergency

SPECIFICATION

Maximum Overall Length	70.7"	1795 mm
Minimum Overall Length	68.7"	1745 mm
Maximum Overall Height	88.6"	2250 mm
Minimum Overall Height	62.6"	1590 mm
Legs Open - External Width	55.1"	1400 mm
Legs Open - Internal Width	49.0"	1245 mm
Legs Closed - External Width	33.2"	845 mm
Legs Closed - Internal Width	26.8"	680 mm

WEIGHTS

Mast, Base and Boom Assembly	240.3 lb	109 kg
Power Pack	6.6 lb	3 kg
Total	246.9 lb	112 kg
6-Point Cradle	19.8 lb	9 kg

Specifications may vary due to manufacturing tolerances.



Best-in-Class Effective Lifting Range and Technology to Promote User Compliance

The Hoyer® HPL500 is a versatile, heavy-duty mobile patient lift that can easily handle most any patient handling task. The lift has features of a premium patient lift with a price you would expect to pay for a mid-range patient lift. Your patient will be safer and less anxious because they are at a greater distance from the lifting mechanism during transfer. This is accomplished by the HPL500's unique ELR (Effective Lifting Range) making it the preferred choice for caregivers.



EFFECTIVE LIFTING RANGE (ELR)



Patients will be safer and less anxious as the ELR keeps them at a greater distance from the lifting mechanism during critical transfers: chair-to-chair, bed-to-chair, floor-to-chair and chair-to-bath.

STANDARD POWERED BASE



Powered leg adjustment allows the caregiver to open and close the legs without bending, twisting or use of force.

OPTIONAL MANUAL BASE



The optional manual base enables caregivers to use their leg muscles and bodyweight to easily open and close the base legs.

OPTIONAL SCALE



Scale is simple to operate and has a "zeroing out" feature that allows you to weigh the patient during transfer process, without including the weight of the sling.



SAFE WORKING LOAD: 500 LB / 227 KG



HOYER SMART MONITOR

- ◊ Lift Cycle Counter
- ◊ Overload Protection
- ◊ Service Reminder
- ◊ Emergency

SPECIFICATION

Maximum Overall Length	54.4"	1382 mm
Minimum Overall Length	50.1"	1273 mm
Maximum Overall Height	83.7"	2125 mm
Minimum Overall Height	56.4"	1433 mm
Legs Open - External Width	49.5"	1257 mm
Legs Open - Internal Width	44.9"	1141 mm
Legs Closed - External Width	27.4"	696 mm
Legs Closed - Internal Width	22.4"	569 mm

WEIGHTS

Mast, Powered Base and Boom	98.9 lb	44.9 kg
Power Pack	6.1 lb	2.8 kg
Powered Base Total	105 lb	47.6 kg
Mast, Manual Base and Boom	100.8	45.7 kg
Manual Base Total	106.9 lb	48.5 kg

Specifications may vary due to manufacturing tolerances.



Best-in-Class Value Bariatric Lift with Technology to Promote User Compliance

The Hoyer® HPL700 is both sturdy and robust with a Safe Working Load of 700 lb. It is compatible with multiple spreader bars, allowing caregivers to use this one lift for patients considered bariatric and non-bariatric alike. This lift has been designed to be configured with or without a seamlessly integrated scale. The HPL700 is also equipped with unique Hoyer Smart Monitor technology that accurately records and displays vital lift utilization and service data.



INTERCHANGEABLE CRADLE OPTIONS



Compatible with multiple spreader bars, the interchangeable cradle options increase versatility, allowing caregivers to make the best choice for patients.

POWERED BASE



The powered base allows the legs to be opened and closed to enable access around armchairs, wheelchairs, and similar obstacles without bending or twisting.

ERGONOMIC PUSH HANDLE



Large contoured handle promotes easier maneuverability and provides protection for the control system from incidental damage.

OPTIONAL SCALE



Easy to use with intuitive controls, the digital scale is NAWI Class III rated and ideal for patient monitoring. Importantly, it does not compromise lifting height.



SAFE WORKING LOAD: 700 LB / 318 KG



HOYER SMART MONITOR

- ◊ Lift Cycle Counter
- ◊ Overload Protection
- ◊ Service Reminder
- ◊ Emergency

SPECIFICATION

Maximum Overall Length	56"	1423 mm
Minimum Overall Length	55"	1397 mm
Maximum Overall Height	81"	2058 mm
Minimum Overall Height	57.75"	1467 mm
Legs Open - External Width	46.25"	1175 mm
Legs Open - Internal Width	42.25"	1073 mm
Legs Closed - External Width	27.5"	699 mm
Legs Closed - Internal Width	23.5"	597 mm

WEIGHTS

Mast, Base and Boom Assembly	143.4 lb	65 kg
Power Pack	6.6 lb	3 kg
Total	150 lb	68 kg
Base Assembly	83 lb	38 kg
Mast & Boom Assembly (no battery)	40.4 lb	18 kg

Specifications may vary due to manufacturing tolerances.



Electric Version of Hoyer's Most Popular Product for Homecare

This lift is designed to be as comfortable as it is convenient, featuring a reverse-mounted actuator for increased knee clearance and ergonomic handle grips that reduce strain on the operator. The HPL402 features a mechanical downward release lever which allows patient moves to be performed without power, another important safety feature in the event of a power outage. The unit also features leg guards and caster bumpers to prevent damage to walls and furniture during transfers.



POWERED BOOM



Operating the powered patient lift is easy with its hand control and battery where a manual lift may be a challenge.

MANUAL LEG



Easily widen and narrow the base by pulling the adjustment handle back to unlock, right to widen and left to narrow the base.

LOW BASE



Low base needs only 5.5" clearance which makes it easy to roll under a bed or chair.



SAFE WORKING LOAD: 400 LB / 181 KG

SPECIFICATIONS		
Overall Length	44.8"	1137 mm
Height of Boom at Highest Articulation	78"	1981 mm
Height of Boom at Lowest Articulation	30.5"	775 mm
Width of Base - Open	39.5"	1003 mm
Width of Base - Closed	24"	610 mm

WEIGHTS		
Total	93 lb	42.2 kg

Specifications may vary due to manufacturing tolerances.



The Most Popular Lift for Homecare

Our most popular Homecare lift, the HML400 Hoyer® Hydraulic Patient Lift has an ergonomically placed hydraulic pump for ease of use. The pump handle can be rotated from side to side allowing for operation from either side of the lift. This manual lift has an angular design with a non-sway cradle for extra stability. The “U” shaped base can be adjusted for easier access to wheelchairs and other furniture. The HML400 can be disassembled for easy storage and transportation.



“This Hoyer lift has made a huge difference for me and my caregivers. It makes things so much easier, especially when my husband is using it to get me situated for one of our movie nights or to put me to bed.”

Tasha Schuh, former Ms. Wheelchair USA (2012-2013)



*Optional powered conversion kit available.

DISASSEMBLES FOR STORAGE



The mast and base easily separate for storage or travel.

PUMP HANDLE ROTATION



Convenient rotating pump-handle allows for operation from both sides of the lift.

ADJUSTABLE “U” LEGS



When closed, U-legs facilitate maneuverability through doors and around corners. Expanded, legs allow for better positioning over commodes or chairs.



SAFE WORKING LOAD: 400 LB / 181 KG

SPECIFICATIONS		
Overall Length	43.5"	1105 mm
Height of Boom at Highest Articulation	77"	1956 mm
Height of Boom at Lowest Articulation	28"	711 mm
Width of Base - Open	39.5"	1003 mm
Width of Base - Closed	24"	610 mm

WEIGHTS		
Total	84 lb	38.1 kg

Specifications may vary due to manufacturing tolerances.



the
treatment
centre

Stand-Aid Lifts



ELEVATE



JOURNEY



HSA SERIES



SWITCH



Heavy-Duty Stand Aid with an Extensive Feature Set Supporting Patient Monitoring and Rehabilitation

The Elevate is a high-performance active lift designed to improve the lifting experience for both the caregiver and the patient. It is both sturdy and compact with a maximum safe working load of 440 lb / 200 kgs. An optional digital scale allows the caregiver to precisely weigh a patient during the transfer process, saving time and avoiding unnecessary patient disruption.



REMOVABLE FOOT REST



The foot rest transforms the lift into a valuable restorative care aid, allowing the patient to fully stand and walk under close supervision.

POWERED LEG ADJUSTMENT



Powered leg adjustment allows the caregiver to open and close the legs without bending or twisting or use of force.

ADJUSTABLE KNEE PAD



Contoured, height adjustable knee pad offers high-level comfort and accommodates a range of patient sizes.

OPTIONAL CLASS III DIGITAL SCALE



Simple and intuitive controls allow precision weight monitoring during transfer, saving valuable time for caregivers.



SAFE WORKING LOAD: 440 LB / 200 KG



HOYER SMART MONITOR

- ◊ Lift Cycle Counter
- ◊ Overload Protection
- ◊ Service Reminder
- ◊ Emergency

SPECIFICATION

Maximum Overall Length	43.3"	1100 mm
Minimum Overall Length	41.0"	1040 mm
Maximum Overall Height	65.5"	1665 mm
Minimum Overall Height	48.4"	1230 mm
Legs Open - External Width	39.1"	995 mm
Legs Open - Internal Width	34.3"	870 mm
Legs Closed - External Width	24.8"	630 mm
Legs Closed - Internal Width	20.0"	510 mm

WEIGHTS

Mast, Base and Boom Assembly	127.3 lb	59 kg
Power Pack	6.6 lb	3 kg
Total	136.4 lb	62 kg
Base Assembly	40.7 lb	18.5 kg
Mast & Boom Assembly (no battery)	66 lb	30 kg

Specifications may vary due to manufacturing tolerances.



Versatile and Portable Stand Aid with Compact Footprint to Allow Navigation in Confined Spaces

The Journey is an ultra-compact, folding stand aid with best-in-class functionality. Both lightweight and nimble, it can be folded for easy storage and transportation. The unique adjustable cradle supports a wider range of patient heights and sizes, allowing your facility to have one lift that meets the need of many.



UNIQUE FOLDING DESIGN



Compact folding design enables transportation outside the confines of the home and allows the Journey to stand unassisted when stored.

ADJUSTABLE CRADLE



Unique adjustable cradle supports a range of patient heights and sizes and lends itself to transfers from lower surfaces.

ADJUSTABLE KNEE PAD



Contoured, height adjustable knee pad offers high level comfort and accommodates a large range of patient sizes.

REMOVABLE FOOT REST



The foot rest transforms the lift into a valuable restorative care aid, allowing the patient to fully stand and walk under close supervision.



SAFE WORKING LOAD: 341 LB / 155 KG



HOYER SMART MONITOR

- ◊ Lift Cycle Counter
- ◊ Overload Protection
- ◊ Service Reminder
- ◊ Emergency

SPECIFICATION

Maximum Overall Length	39.4"	1000 mm
Minimum Overall Length	36.8"	935 mm
Maximum Overall Height	63"	1600 mm
Minimum Overall Height	44.5"	1130 mm
Legs Open - External Width	38.2"	970 mm
Legs Open - Internal Width	34.5"	875 mm
Legs Closed - External Width	27"	685 mm
Legs Closed - Internal Width	22.2"	590 mm

WEIGHTS

Mast, Base and Boom Assembly	82.4 lb	37.4 kg
Power Pack	6.2 lb	2.8 kg
Total	88.6 lb	40.2 kg
Base Assembly	30.2 lb	13.7 kg
Mast & Boom Assembly (no battery)	42.3 lb	19.2 kg

Specifications may vary due to manufacturing tolerances.

HSA Series

Active Transfer Devices for Use in All Settings

The HSA400 and HSA450 are active transfer devices for users who, although partially impaired, have some weight-bearing ability, trunk strength, and the ability to participate in their transfers. They keep the patient engaged and active in all transfers. Transport functions of all types are quick and require minimal caregiver assistance. Users grasp the middle bar and pull themselves up into position. A padded split seat is positioned so that it swings out to allow loading or unloading, and then swings back to form a secure and comfortable seat for transport. They are also an excellent alternative to wheelchairs for toileting.



HSA400

SWING SEAT



Padded swing seats come together to form a stable and secure yet comfortable sitting surface. Seats fold flat against the side arms when not in use.

ADJUSTABLE KNEE PAD



Contoured, height adjustable knee pad offers high-level comfort and accommodates a large range of patient sizes.

HSA400 BASE



A small footprint base allows access to patients in tight quarters. Front legs taper inwards allowing the base to fit between the wheels of a standard wheelchair.

HSA450 ADJUSTABLE BASE



Base open/close functionality increases accessibility to patients. A simple and robust mechanical foot lever provides open/close functionality.



HSA450



HSA400 SAFE WORKING LOAD: 400 LB



HSA450 SAFE WORKING LOAD: 450 LB

SPECIFICATION	HSA400	HSA450
Maximum Overall Length	31.1"	35.4
Minimum Overall Length	31.1"	34.5
Maximum Overall Height	43"	43.3
Minimum Overall Height	43"	43.3
Legs Open - External Width	16.2"	37
Legs Open - Internal Width	25.1"	33.5
Legs Closed - External Width	29.9"	23.6
Legs Closed - Internal Width	22.6"	22.3

WEIGHTS		
HSA400 Total	60 lb	27.2 kg
HSA450 Total	71 lb	32.2 kg

Specifications may vary due to manufacturing tolerances.



A Versatile Solution to Assisted Standing and Transfers

The Switch is designed to help a person with reduced mobility stand from a seated position and enable transfer from one point to another. As a rehabilitation aid, the Switch actively encourages the user to participate in the standing process, engaging core muscle groups while improving strength and function.

VERSATILE AND EASY TO MANEUVER



Two independently braked central wheels and four corner mounted swivel casters ensure excellent stability and maneuverability.

EASY TO TRANSPORT AND STORE



The frame and base plate quickly separate into two components for easier transportation, for example in the trunk of a car.

ADJUSTABLE KNEE PAD



Contoured, height-adjustable knee pad offers high-level comfort and accommodates a large range of patient sizes. Optional padded covers provide additional comfort.

LOW PROFILE SCULPTED BASE



Low ground clearance provides maximum stability during use. The angled recess ensures close access around bathroom toilets.



SAFE WORKING LOAD: 397 LB / 180 KG

HOYER PATIENT POSITIONING BELT



- ◊ Side handles
- ◊ Non-slip inner layer
- ◊ Compatible with the Switch

SPECIFICATION

Overall Height	46.1"	1170 mm
Overall Length	26.4"	670 mm
Overall Width	21.7"	550 mm
Knee Pad Height (Top of Pad)	13.6"-20.3"	345-515 mm
Foot Plate Height	1.8"	45 mm
Ground Clearance	1"	25 mm
Turning Radius	29.9"	760 mm

WEIGHTS

Frame	12.1 lb	5.5 kg
Base	23.1 lb	10.5 kg
Total	35.3 lb	16 kg

Specifications may vary due to manufacturing tolerances.



Ceiling Lifts



ELARA



CEILING TRACK



VOYAGER



PORTABLE



FREE STANDING



The Illuminating Solution for Your Ceiling Lift Needs

Designed with the patient, caregiver and service personnel in mind, the Hoyer Elara® emphasizes safety. Tested to the most stringent international standards, it incorporates an extensive set of safety systems to ensure the patient and caregiver feel secure at all times. A refreshing blend of contemporary design and maximum functionality ensures the Elara meets your needs today and as they evolve.



HOYER HALO NIGHT ILLUMINATION



Elara's illumination helps patients sustain their natural circadian rhythm while caregivers perform vital tasks in a safe, warmly lit environment.

UNIQUE ELARA CHAUFFEUR™



The 4-wheel drive power traverse option offers in-rail traction and reduces the effort required by the caregiver when transferring and positioning patients.

EXTENSIVE LIFTING RANGE



With an optional tape extension kit, the Elara can transfer patients from the floor to high surfaces, making it suitable for a variety of environments.

SCALE OPTION



Weight fluctuations can be early warning signs of healthcare concerns. A digital scale is available, offering medically approved accuracy and monitoring.

SAFETY FEATURES	
Soft Start/Stop	Overload Protection
Emergency Stop	Emergency Lower (Electric)
Emergency Lower (manual)	Up/Down Limit Switch
Auto Safety Brake	On-board Warning Notifications (visual/audible)

POWER FEATURES	
Sleep Mode (power save)	Battery Level Indicator
Low Battery Alarm	Charging Indicator

MODEL	POWER TRAVERSE	SAFE WORKING LOAD
Elara 500 (2-way)	-	500 lb / 227 kg
Elara 500 (4-way)	✓	500 lb / 227 kg
Elara 600 (2-way)	-	625 lb / 284 kg
Elara 600 (4-way)	✓	625 lb / 284 kg

SPECIFICATIONS	
Weight (excluding spreader bar)	26.4 lb / 12 kg
Charging Time (max)	6 Hours
Lifts Per Charge (176 lb / 80 kg)	40
Lifting Range	94.5" / 2400 mm
Loaded Lifting Speed	Up to 1.34" per sec 34 mm per sec
Chauffeur Speed (4-way)	5.9" per sec 150 mm per sec
Noise	63 dB
Ingress Protection - Lift	IPX2
Ingress Protection - Hand Control	IPX6

Specifications may vary due to manufacturing tolerances.

HOYER® SMART MONITOR

The Smart Monitor accurately records usage and diagnostic data for your lift as well as potential misuse. The intelligent system reminds you to schedule key service and maintenance, helping to safeguard the lift's optimum condition, reducing downtime and promoting product longevity and uninterrupted care.

The following data points are readily accessible from the menu:



LIFT CYCLE COUNTER

Accurately records and displays the total number of lift cycles performed.



WORK COMPLETED

Records the precise amount of work completed by the lift's motor over its lifetime.



OVERLOAD DETECTION

Records the number of instances a lift in excess of the safe working load has been attempted.

SIMPLIFIED SERVICE & MAINTENANCE

The Elara is purposely designed for ease of servicing, requiring no tools for a number of common tasks. This reduces downtime and contributes to a more efficient care environment for all.



LIFT



TWIST



LOWER

Detachment from the rail takes a matter of seconds. Simply disconnect the charge lead on top of the lift motor and lift, twist and lower the Elara from its trolley. Attachment is in reverse sequence; remember to connect the charge lead to finish.



The charge lead is easily connected or disconnected from the lift motor.



The Elara's outer covers are removable, allowing quick access to internal components for service and maintenance.





DATA DOWNLOAD

The intelligent Hoyer Smart Monitor continuously records detailed usage data, enabling the service engineer to understand exactly how the lift has been used. A full diagnostic report is readily available for download via computer connectivity.

CEILING & INSTALLATION SERVICES

Hoyer® is renowned for its consistent, top -performance throughout the continuum of care, and its ceiling lifts and installation services are no different.

- ◊ Experience with all phases of construction
- ◊ Complimentary CAD designs based on project needs
- ◊ Installation services throughout the US and Canada
- ◊ Individualized solutions such as our unique Hoyer Crosstrack which seamlessly transitions patients through doorways
- ◊ Aesthetically pleasing rail arrangements even in difficult structures
- ◊ Offers a wide range of track, transitions and accessories offering incredible versatility
- ◊ A choice of six track styles, from aesthetically pleasing flush mount to heavy duty, offers incredible versatility

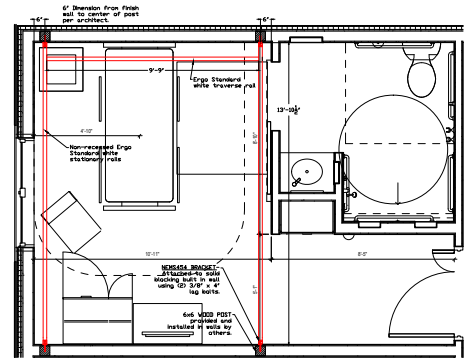

TURN TABLE (90°)

Allows a patient to be transferred between adjoining rail systems. The turntable may be installed in places where 2, 3 or 4 rails cross each other.



CURVED RAIL

Installed when it is necessary to change the direction of the rail in a single track system.

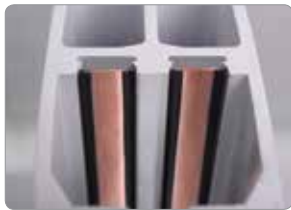

IN-RAIL CHARGE

Ensures the lift motor is constantly charging during use. This option is ideal in high-use environments where continuous power is a necessity.



CROSTRACK

With the use of barn style doors, sliding doors, allows transition from one room to another.



LT Rail



LT Rail with Flange



Standard Rail

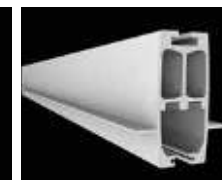

Standard Rail with Flange



Max Rail



HD Rail



Unique, Portable Ceiling Lift Solution for Residential Care

Designed to be used with the Easytrack* System, the Voyager®* Portable Lift is incredibly lightweight while maintaining a powerful lifting capacity of 440 lb. It can easily be moved from room to room and has dual controls with a removable handset.

The Voyager uses a two-, three-, or four-posted Easytrack System (the track is purchased separately), which is easy to install and does not require permanent fixings or structural changes. The system is compact, making it a great option for use in a small bedroom or bathroom.

QUICK-RELEASE LIFT TAPE



Enables fast and efficient transfers and trouble free attachment to rail systems, avoiding any need to physically lift the motor unit.

SOFT START AND STOP



The soft start-and-stop feature ensures the patient is transferred safely and comfortably.

DUAL CONTROLS



The dual controls on the front of the Voyager, coupled with a removable handset, allow total flexibility, ensuring the lift can be operated at all times during a patient transfer.

REMOVABLE BATTERY



The battery pack is easily removed for charging and the use of a second battery ensures 24-hour, continuous availability of your lift.



SAFE WORKING LOAD: 440 LB / 200 KG

FEATURES	
Soft Start and Stop	Emergency Stop
Quick Release Tape Mechanism	Compatible with Full Hoyer Sling Range

SPECIFICATION	
Emergency Lower	Manual
Low Battery Indicator	Audible
Battery Capacity (load: 165 lb/75 kg)	Up to 30 transfers
Battery Charger	Freestanding
Weight (with battery)	12.1 lb / 5.5 kg
Vertical Speed	1.6"/40 mm per sec

Specifications may vary due to manufacturing tolerances.

*Voyager and Easytrack are a registered trademarks of Arjo



Unique, Portable Ceiling Lift Solution for Residential Care

The Easytrack* system is a unique overhead portable track designed for the Voyager Portable lift. It requires no permanent attachments, no structural alterations, and can be assembled in as little as five minutes by just one person. The Easytrack is the ideal solution when a fixed ceiling track cannot be installed.



SAFE WORKING LOAD: 440 LB / 200 KG

SPECIFICATION	EASYTRACK 2 POST	EASYTRACK 3 POST	EASYTRACK 4 POST
Ceiling Height Range	83.5"/2130mm - 108.1"/2745mm	88"/2235mm - 108.1"/2745mm	83.5"/2130mm - 108.1"/2745mm
Rail Length Range	74.8"/1900mm - 124.4"/3160mm	74.8"/1900mm - 124.4"/3160 mm	118.1" / 3000 mm
Rail Weight (each)	12 kg	12 kg	9 kg
Post Weight (each)	4 kg	4 kg	4 kg
Total Weight	20 kg	42.5 kg	57 kg
Standard Kit	✓	✓	✓
Wall Bracket Option	✓	✓	-
Bath Bracket Option	✓	✓	-
Multi-Wall Bracket Option	✓	✓	-

Specifications may vary due to manufacturing tolerances.

SIMPLE INSTALLATION The unique floor-to-ceiling design eliminates the need for attachments, alterations or electrical installations.

MULTI-POST OPTIONS The 2-, 3-, or 4-post options solve patient handling problems in nearly every room layout (see opposite).

TELESCOPIC POST Allows the Easytrack to be used with a variety of ceiling heights.

FOOTPRINT The small feet of the Easytrack allows use even in the smallest bedroom or bathroom where a conventional floor lift could not be maneuvered.

EASY TO ASSEMBLE

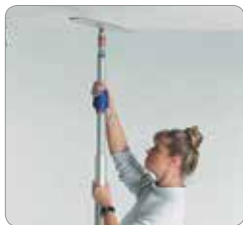

Extend posts and rotate to lock in place



Fix one end of rail onto the post.



Extend rail to required length and fix rail onto second post.



Fix end cap to lock rail in place.



*Easytrack is a registered trademark of Arjo

Easytrack* Options

There are many variations of the Easytrack system's with 2-, 3-, and 4-post configurations, thereby providing a solution for almost any setting.

2-POST SYSTEM

The standard 2-post Easytrack is suited for transfer over a bed or bath in a peninsular setting:



2-Post Easytrack
(92000)



2-Post Easytrack with Bath Bracket (92001)



2-Post Easytrack with Wall Bracket (92002)

3-POST SYSTEM

The 3-post Easytrack is suited for transfer over a bed or bath and down a room. This system negates the need for a traditional curved track:



3-Post Easytrack
(93000)



3-Post Easytrack with Bath Bracket (93001)



3-Post Easytrack with Wall Bracket (93002)

4-POST SYSTEM



4-Post Easytrack operates like a traditional x-y system covering all 4 corners of a room. System is not telescopic. (94000)

*Easytrack is a registered trademark of Arjo



Unique, Portable Ceiling Lift Solution for Residential Care

The Easytrack FS™* is a lightweight, free-standing portable overhead track system, based on many of the same principles as the current Easytrack range. Unlike the existing Easytrack system, the Easytrack FS does not rely on support from the ceiling thereby removing any potential structural issues that may be encountered.

LIGHTWEIGHT COMPONENTS The components ensures ease of storage and transportation.

SELF LOCATING POSTS The posts are self-locating and require no additional tools or fixings.

TELESCOPIC ADJUSTMENT The Easytrack FS incorporates telescopic post and track adjustment for ease of use.

SPRING LOADED POSTS To aid set-up, the posts are spring loaded so that the height can be adjusted effortlessly.

AUTO LOCKING MECHANISM The posts automatically lock into place once adjustment has been made.

CARRY BAGS This optional accessory aid both transportation and storage.

EASY TO ASSEMBLE

The EasyTrack FS is designed to be assembled by a single person in a matter of minutes.



9720010



SAFE WORKING LOAD: 440 LB / 200 KG

SPECIFICATION		
Floor to Top of Rail	72" - 94.7"	1830-2406 mm
Floor to Bottom of Rail	66.1" - 88.8"	1680-2256 mm
Exterior Width	87" - 127.2"	2210-3230 mm
Interior Width	42.3"	1075 mm
Footplate Width	5.9"	150 mm
Rail Weight	30.9 lb	14 kg
Post Weight (each)	20.9 lb	9.5 kg
Footplate Weight	12.1 lb	5.5 kg

Specifications may vary due to manufacturing tolerances.
*Easytrack FS is a registered trademark of Arjo

Slings & Accessories



PASSIVE / CEILING SLINGS



ACTIVE SLINGS



SPREADER BAR AND CRADLES



ACCESSORIES

ABOUT HOYER® SLINGS

About Hoyer Slings

Hoyer has been designing and manufacturing slings, the all-important patient interface, for over 70 years. There is a Hoyer sling to meet every need. Fabric options are available, as well as specialty slings for hygiene, toileting, repositioning, turning, and gait training. Hoyer slings have many common attributes, which make them easier to train and easier to use.



COLOR CODED FOR SIZING with binding that provides clear recognized size information at a glance.



LABEL PROVIDES essential information about the sling including a unique serial number for traceability when completing inspection and audit records.

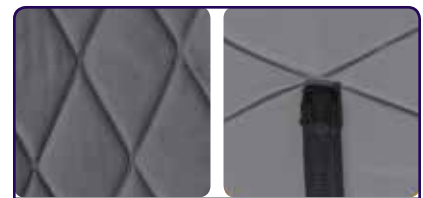

PADDING provides additional comfort and support to delicate areas and our webbing straps have covered ends to protect the patient's skin.



COLORED LOOP STRAPS provide adjustment and the correct positioning angle for the 6-point spreader bar system.



POSITIONING HANDLES on our slings are carefully positioned to offer ease of handling.



DIGNITY STRAPS top the patient's legs from splaying while transferring, to maintain dignity.



CENTERLINE MARKERS aid the caregiver in the correct positioning of the sling, especially when inserting the sling before an off the bed or floor transfer.

IMPORTANT Remember to check the safe working load of the lift prior to lifting a patient as it may differ from that of the sling.

ABOUT HOYER® SLINGS

Sling Sizing

Hoyer slings are available in a range of sizes to accommodate variety in height, shape and weight of patients. Hoyer uses a simple color-coding system that ensures the size of your sling is instantly recognizable. The outer-edge binding of the sling is color coded-as shown. Hoyer’s bariatric slings use a striped system to help differentiate from the standard range.



Size	Color	Recommended Weight Range									
		35 lb 15.9 kg	75 lb 34 kg	100 lb 45.4 kg	125 lb 56.7 kg	150 lb 68 kg	175 lb 79.4 kg	200 lb 90.7 kg	275 lb 124.7 kg	350 lb 158.8 kg	500 lb 227 kg
X Small	Brown	Brown									
Small	Red		Red								
Medium	Yellow			Yellow							
Large	Green					Green					
X Large	Blue							Blue			

Hoyer Bariatric Slings

All Hoyer bariatric slings are rated to a safe working load of 850 lb /385 kgs. Due to the varying nature of bariatric patient shapes and sizes, it becomes increasingly difficult to provide a guide on sling size based on weight alone. Patients should be individually assessed to ascertain the correct size sling.

Size	Color	Color Example
M	Yellow with White Stripes	
L	Green with White Stripes	
XL	Red with White Stripes	
XXL	Yellow with White Stripes	
3XL	Green with White Stripes	
4XL	Blue with White Stripes	
5XL	Black with White Stripes	

IMPORTANT It is very important to use the correct sized sling and ensure it is properly fitted before attempting to lift. This will ensure the person being lifted feels safe, dignified and comfortable. It will also provide caregivers with confidence that they can achieve the transfer required and that the procedure will be executed in an effective and safe manner.



Hoyer slings can be customized outside of their standard specification to include adjustments to sizing. Should a standard sling size be deemed unsuitable, we can create a tailored sling to meet patient specific requirements. Contact Joerns Healthcare for more information.

ABOUT HOYER® SLINGS

Material Options



POLYESTER DISPOSABLE available on select models

- Developed for single patient use which helps reduce the risks of cross infection
- In order to maintain their integrity, these slings must not be laundered or exposed to water



POLYESTER / PADDED

- Strong, hard-wearing material is a consistent standard for Hoyer slings over the years
- Available in medium gray with selected sling models offered in alternative colors
- Padded option provides additional comfort and support to delicate areas



POLYESTER NET

- Quick drainage and drying properties are ideally suited to bathing and/or swimming pool environments
- Complementary to the polyester solid
- Net (or mesh) variant is also a common option through the Hoyer sling range



WOVEN SPACER

- Cushioned and breathable 3D woven spacer fabric
- Offers high air permeability and good drainage.
- Two-way stretch characteristics enable material to adapt to contours of the patient for higher levels of comfort and support

ABOUT HOYER® SLINGS

Spreader Bar and Cradle Options

The Hoyer lift range has the option of two sling attachment systems that provide the caregiver greater choice in selecting the most appropriate sling and cradle for a task. The Advance, Presence and Stature can be used with either the 6-point spreader bar or a 4-point positioning cradle. Both systems have their place. More importantly, this allows the caregiver to choose exactly the right sling for the patient and task in question.



6-POINT SPREADER BAR

6-POINT SPREADER BAR

The 6-point spreader bar uses slings with webbing loops that allow positioning adjustments to be made by selecting the different colored loops. The attachment straps at shoulder level determine the position of the back, ranging from upright to reclined. Similarly, the attachment straps at the legs determine the approximate degree of flexion at the hip, from around 90° to 45°.

The position achieved by adjusting the loops will depend upon the height and build of the patient. The rule of thumb is the shorter the shoulder straps, the more upright the patient will be.



4-POINT POSITIONING CRADLE
(powered version shown)

4-POINT POSITIONING CRADLES

The 4-point positioning cradle uses the safety clip system, and adjustment is made by rotating the cradle handle either down or up to obtain an upright or reclined position for the patient. Both manual and powered cradles are available.



INSERT



PULL/LOCK



SECURE



SAFE



BARIATRIC CRADLE

BARIATRIC CRADLE

The Bariatric Cradle is used when a large distance between the back and leg straps is appropriate, primarily for lifting and transferring bariatric patients. The Bariatric Cradle is compatible with the Calibre and HPL700 patient lifts and all Joerns bariatric slings. Additional flexibility is provided when a range of sling straps are used to position the patient in the sling. For example, extension straps can supplement the sling to open the hip angle of the patient still further for safer, more comfortable transfers.

ABOUT HOYER® SLINGS

Sling Selection and Risk Assessment

Selecting a sling for an individual patient involves more than simply measuring their size and deciding what the sling will be used for. To be sure that a sling meets specific requirements and is the most appropriate sling available, many further aspects need to be considered as part of the selection process. Some of these are discussed briefly here.

1

MOBILITY ASSESSMENT

It is necessary to establish a sling's compatibility with the lift or lifting system and the level of independence of the patient.

2

TYPE OF TRANSFER TASK

Determine the type of transfer task(s) that are desired, together with the frequency with which they will occur. This relates closely to the functional requirements of the sling (for example: a sling that is to be used for toileting may require a commode aperture).

3

SLING SUPPORT LEVELS

Different types of slings provide different levels of support for the patient being lifted. The support level is determined by the shape and structure of the fabric, with the main body of the sling providing support to the back and head (1) and the leg straps providing support to the thighs, hips and buttocks (2/3).



4

INFORMATION ABOUT THE CAREGIVER(S)

Experience and training of the caregiver(s) must be considered. Some slings are more complicated than others to fit and a caregiver may be reluctant to use a sling if the process of fitting it is too complex. The number of caregivers available to fit the sling as well as the total number of caregivers involved in a patient's care may also be important considerations.

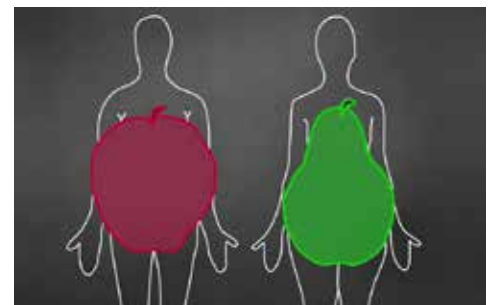

5

INFORMATION ABOUT OTHER EQUIPMENT

Identify any associated equipment that is involved in a transfer, such as seating, beds, trolleys, toilets or therapy equipment to ascertain that the lift and sling will work effectively with these items.

ABOUT HOYER® SLINGS

Matching the Right Sling to the Task (Best Practice Guide)

To simplify the process of sling selection, we have developed a chart to help guide you in the appropriate use of each sling for a given task. There will, of course, be exceptions to this guide and Joerns Healthcare recommends that a full patient risk assessment is carried out prior to any transfer to determine individual requirements.

	SLING MODEL	EXAMPLE PATIENT LIFT	BED TO CHAIR	CHAIR TO CHAIR	COMMODE/ TOILET TRANSFER	BATH/ SHOWER TRANSFER	FLOOR TO BED/ CHAIR	TURNING ASSIST	REHAB/ ASSISTED STANDING
PASSIVE / CEILING	Full Back	Loop	✓	✓	✓	✓ (1)	✓		
	Access	Loop	✓	✓	✓				
	Access with Head Support	Loop	✓	✓	✓				
	Quickfit	Loop	✓	✓	✓	✓ (1)	✓ (2)		
	Quickfit Deluxe	Loop	✓	✓	✓	✓ (1)	✓ (2)		
	Long Seat	Loop	✓	✓	✓	✓ (1)	✓	✓	
	Long Seat with Commode (a)	Loop	✓	✓	✓	✓ (1)		✓	
	Hammock	Loop	✓	✓			✓	✓	
	U sling	Loop Classic	✓	✓	✓	✓ (1)	✓ (2)		
	U sling with Head Support (a)	Loop Classic	✓	✓	✓	✓ (1)	✓		
	One Piece	Loop Classic	✓	✓	✓		✓		
	One Piece with Commode (a)	Loop Classic	✓	✓	✓		✓ (2)		
	Repositioning	Loop	✓	✓	✓	✓ (1)	✓ (2)	✓	
	Twin Turner	Loop						✓	
	Limb	Loop							✓
	Standing Harness	Loop							✓
	Comfort	Clip	✓	✓	✓	✓ (1)	✓		
	Comfort Access (a)	Clip	✓	✓	✓				
	Comfort Access Head Support	Clip	✓	✓	✓				
	Comfort Amputee	Clip	✓	✓	✓		✓	✓	
ACTIVE	Deluxe Stand-Aid	Loop Stand-Aid	✓	✓	✓				✓
	Deluxe Transport	Loop Stand-Aid	✓	✓	✓				✓
	Stand-Aid Clip (a)	Clip Stand-Aid	✓	✓	✓				✓
	Patient Handling Belt	Clip Switch	✓	✓	✓				✓

(a) Note added to sister sling

(1) Net version recommended

(2) Head support recommended

HOYER® SLINGS

Full Back Sling



SAFE WORKING LOAD:
500 lb / 227 kg



DEPENDENCY:
Complete Dependence
FIM 1-2



ATTACHMENT:
Loops
6-Point Spreader Bar



MATERIAL OPTIONS:
Padded Disposable
Mesh

This is a more specialized sling. It incorporates integral boned head support and padded leg pieces. Fitted correctly, this sling will give full protection for patients who go into extension, have involuntary movements or behavioral problems.

AREA	X SMALL (inch/mm)	SMALL (inch/mm)	MEDIUM (inch/mm)	LARGE (inch/mm)	X LARGE (inch/mm)
A	31.9 / 810	38.6 / 980	45.5 / 1180	53.5 / 1360	66.5 / 1690
B	20.5 / 520	20.9 / 530	25.2 / 640	28.3 / 720	30 / 890
C	40.6 / 1030	41.7 / 1060	46.9 / 1190	52.8 / 1340	64.2 / 1630
D	13 / 330	14.6 / 370	16.5 / 420	17.3 / 440	17.7 / 450



Access Padded Sling



SAFE WORKING LOAD:
500 lb / 227 kg



DEPENDENCY:
Complete Dependence
FIM 1-2



ATTACHMENT:
Loops
6-Point Spreader Bar



MATERIAL OPTIONS:
Padded

This sling is designed specifically to facilitate the toileting procedure by allowing the removal of clothing. It is NOT a general-purpose sling and will suit only 25% of patients. Patients must be in a sitting position to use this sling.

AREA	X SMALL (inch/mm)	SMALL (inch/mm)	MEDIUM (inch/mm)	LARGE (inch/mm)	X LARGE (inch/mm)
A	23.6 / 600	27.6 / 700	33.5 / 850	41.3 / 1050	51.1 / 1300
B	10.2 / 260	11 / 280	12.2 / 310	13 / 330	15.4 / 390
C	22.4 / 570	26 / 660	35 / 890	39.4 / 1000	44.7 / 1160
D	13.4 / 340	16.4 / 410	20.5 / 520	26.4 / 670	32.3 / 820
Chest Strap Adjustment (maximum length)					
MAX	39.8 / 1010	44.9 / 1140	49.2 / 1250	58.3 / 1480	72.8 / 1850

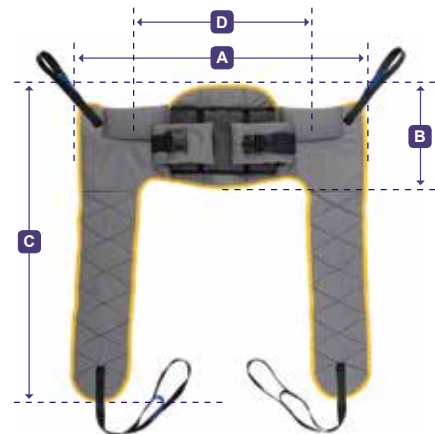

HOYER® SLINGS

Access Padded Sling with Head Support



SAFE WORKING LOAD:
500 lb / 227 kg



DEPENDENCY:
Complete Dependence
FIM 1-2



ATTACHMENT:
Loops
6-Point Spreader Bar



MATERIAL OPTIONS:
Padded



This sling is designed specifically to facilitate the toileting procedure by allowing the removal of clothing. It is NOT a general-purpose sling and will suit only 25% of patients. Patients must be in a sitting position to use this sling. Fitted with integrated head support for additional comfort.

AREA	X SMALL (inch/mm)	SMALL (inch/mm)	MEDIUM (inch/mm)	LARGE (inch/mm)	X LARGE (inch/mm)
A	23.2 / 590	27.2 / 690	32.7 / 830	41.7 / 1060	49.6 / 1260
B	10.6 / 270	11.8 / 300	12.2 / 310	11 / 280	13.4 / 340
C	46.5 / 1180	53.5 / 1360	61 / 1550	63 / 1600	73.2 / 1860
D	17.3 / 440	19.3 / 490	21.3 / 540	23.2 / 590	26.4 / 670



Quickfit Sling



SAFE WORKING LOAD:
500 lb / 227 kg



DEPENDENCY:
Complete Dependence
FIM 1-2



ATTACHMENT:
Loops
6-Point Spreader Bar



MATERIAL OPTIONS:
Padded
Mesh



This sling is an easy-to-fit, general-purpose sling designed to suit approximately 85% of patients. It is available with head support and can be felt lined for additional comfort.

AREA	X SMALL (inch/mm)	SMALL (inch/mm)	MEDIUM (inch/mm)	LARGE (inch/mm)	X LARGE (inch/mm)
A	Special	28.7 / 730	35.4 / 900	43.7 / 1110	Special
B	Special	22 / 560	24.4 / 620	27.6 / 700	Special
C	Special	44.1 / 1120	47.6 / 1210	55.1 / 1400	Special



HOYER® SLINGS

Quickfit Deluxe Sling

SWL **SAFE WORKING LOAD:**
500 lb / 227 kg

DEPENDENCY:
Complete Dependence
FIM 1-2

ATTACHMENT:
Loops
6-Point Spreader Bar

MATERIAL OPTIONS:
Padded Polyester
Mesh

The Quickfit Deluxe sling is suitable for 95% of patients. It is available with head support and can be used for amputees following a careful assessment.

AREA	X SMALL (inch/mm)	SMALL (inch/mm)	MEDIUM (inch/mm)	LARGE (inch/mm)	X LARGE (inch/mm)
A	Special	30.3 / 770	35 / 890	40.6 / 1030	Special
B	Special	24.8 / 630	30.3 / 770	33.5 / 850	Special
C	Special	36.2 / 920	44.1 / 1120	46.5 / 1180	Special



Long Seat Sling

SWL **SAFE WORKING LOAD:**
500 lb / 227 kg

DEPENDENCY:
Complete Dependence
FIM 1-2

ATTACHMENT:
Loops
6-Point Spreader Bar

MATERIAL OPTIONS:
Polyester
Mesh

The Long Seat sling is designed for amputees, but it is also suitable for other patients who have to remain in the sling for an extended period, i.e. during bed making when bathing.

AREA	X SMALL (inch/mm)	SMALL (inch/mm)	MEDIUM (inch/mm)	LARGE (inch/mm)	X LARGE (inch/mm)
A	Special	23.2 / 590	27.1 / 690	28.7 / 730	Special
B	Special	40.2 / 1020	46.1 / 1170	50.4 / 1280	Special



HOYER® SLINGS

Bariatric Hammock Sling

**SAFE WORKING LOAD:**
850 lb / 385 kg**DEPENDENCY:**
Complete Dependence
FIM 1-2**ATTACHMENT:**
Loops
6-Point Spreader Bar**MATERIAL OPTIONS:**
Spacer

This is a more specialized sling. It incorporates integral boned head support and padded leg pieces. Fitted correctly, this sling will give full protection for patients who go into extension, have involuntary movements or behavioral problems.

AREA	X LARGE (inch/mm)	2X LARGE (inch/mm)	3X LARGE (inch/mm)	4X LARGE (inch/mm)	5X LARGE (inch/mm)
A	39.8 / 1010	44.1 / 1120	50 / 1270	58.3 / 1480	68.9 / 1750
B	64.2 / 1630	64.2 / 1630	64.6 / 1640	64.6 / 1640	63.8 / 1620
C	11.4 / 290	12.2 / 310	12.2 / 310	12.2 / 310	12.2 / 310

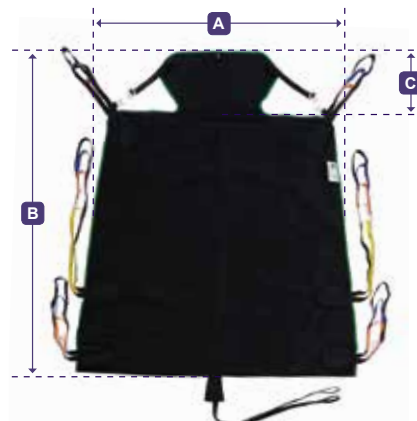

U Sling

**SAFE WORKING LOAD:**
500 lb / 227 kg**DEPENDENCY:**
Complete Dependence
FIM 1-2**ATTACHMENT:**
Loops
6-Point Spreader Bar**MATERIAL OPTIONS:**
Padded

The Universal sling is an easy fit general purpose sling designed to suit approximately 85% of patients. It is available with or without head support for additional comfort.



AREA	X SMALL (inch/mm)	SMALL (inch/mm)	MEDIUM (inch/mm)	LARGE (inch/mm)	X LARGE (inch/mm)
A	Special	33.5 / 851	39.5 / 1003	47 / 1194	51 / 1295
B	Special	32 / 813	38 / 965	42 / 1067	61 / 1549

HOYER® SLINGS

One Piece Sling



SAFE WORKING LOAD:
500 lb / 227 kg



DEPENDENCY:
Complete Dependence
FIM 1-2



ATTACHMENT:
Loops
6-Point Spreader Bar



MATERIAL OPTIONS:
Polyester



This sling is designed for amputees, but it is also suitable for other patients who have to remain in the sling for an extended period, i.e. during bed making when bathing.

AREA	X SMALL (inch/mm)	SMALL (inch/mm)	MEDIUM (inch/mm)	LARGE (inch/mm)	X LARGE (inch/mm)
A	Special	26 / 813	32 / 660	35.5 / 902	Special
B	Special	32 / 660	38.5 / 978	42.5 / 1080	Special



Limb Sling

The Limb sling is designed to assist with the elevation and support of a patient's arm or leg to facilitate examination, care or treatment of wounds. Available with two separate strap configurations, single loops or multi loops.



Twin Turner Sling

The Twin Turner sling is used to assist in turning or "log rolling" a patient as well as maintaining them in position for purposes of hygiene or other care tasks. It is designed to be easily placed and removed as well as providing more access to the patient to provide skin care.







Repositioning Sling

The Repositioning sling is designed to conveniently re-position, turn or transfer the patient. It is made of breathable, pliable mesh material and is normally placed under the top sheet for comfort.



Standing Harness Sling

 SAFE WORKING LOAD: 500 lb / 227 kg	 DEPENDENCY: Complete Dependence FIM 3-4
 ATTACHMENT: Loops 6-Point Spreader Bar	 MATERIAL OPTIONS: Polyester





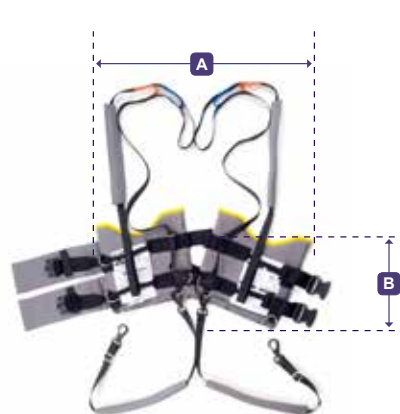

The Standing Harness is a versatile sling used to assist with standing, walking or toileting. The Standing Harness is not a general-purpose sling and requires the patient to be able to partially bear weight.

AREA	X SMALL (inch/mm)	SMALL (inch/mm)	MEDIUM (inch/mm)	LARGE (inch/mm)	X LARGE (inch/mm)
A (min)	11.8 / 300	15.3 / 390	21.2 / 540	34.4 / 875	Special
A (max)	16.1 / 410	23.2 / 590	29.1 / 740	42.3 / 1075	Special
B	4.3 / 110	4.3 / 110	6.3 / 160	6.3 / 160	Special



Comfort Sling

 SAFE WORKING LOAD: 500 lb / 227 kg	 DEPENDENCY: Complete Dependence FIM 1-2
 ATTACHMENT: Clips 4-Point Cradle	 MATERIAL OPTIONS: Padded Mesh





This sling allows correct positioning to be made via the 4 point cradle. The Securi3 clip system ensures no inadvertent detachment of the sling from the cradle. It is ideal for patients who go into extension, have involuntary movements or behavioral problems.

AREA	X SMALL (inch/mm)	SMALL (inch/mm)	MEDIUM (inch/mm)	LARGE (inch/mm)	X LARGE (inch/mm)
A	31.9 / 810	38.6 / 980	46.5 / 1180	53.5 / 1360	66.5 / 1690
B	33.9 / 860	35 / 890	41.7 / 1060	45.7 / 1160	52.8 / 1340
C	51.6 / 1310	53.9 / 1370	62.2 / 1580	69.3 / 1760	82.3 / 2090



HOYER® SLINGS

Comfort Access Padded Sling with Head Support

 SAFE WORKING LOAD: 500 lb / 227 kg	 DEPENDENCY: Complete Dependence FIM 1-2
 ATTACHMENT: Clips 4-Point Cradle	 MATERIAL OPTIONS: Padded





Used with a 4-point cradle, this sling is designed specifically to facilitate the toileting procedure by allowing the removal of clothing. It is NOT a general-purpose sling and will suit only 25% of patients. Patients must be in a sitting position to use this sling. Fitted with integrated head support for additional comfort

AREA	X SMALL (inch/mm)	SMALL (inch/mm)	MEDIUM (inch/mm)	LARGE (inch/mm)	X LARGE (inch/mm)
A	23.2 / 590	27.2 / 690	32.7 / 830	41.7 / 1060	49.6 / 1260
B	10.6 / 270	11.8 / 300	12.2 / 310	11 / 280	13.4 / 340
C	46.5 / 1180	53.5 / 1360	61 / 1550	63 / 1600	73.2 / 1860
D	17.3 / 440	19.3 / 490	21.3 / 540	23.2 / 590	26.4 / 670

*Also available without head support



Comfort Amputee Sling

 SAFE WORKING LOAD: 500 lb / 227 kg	 DEPENDENCY: Complete Dependence FIM 1-2
 ATTACHMENT: Clips 4-Point Cradle	 MATERIAL OPTIONS: Polyester



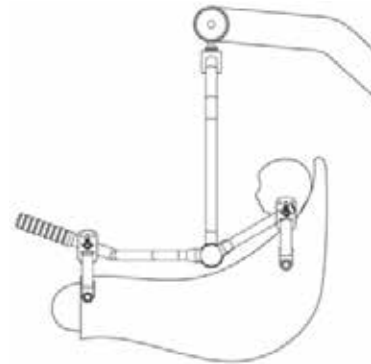

The Amputee Comfort sling is designed for amputees but is also suitable for other patients who have to remain in the sling for an extended period, such as for bed making or bathing. An amputee spreader bar is required for use with the amputee sling.

AREA	X SMALL (inch/mm)	SMALL (inch/mm)	MEDIUM (inch/mm)	LARGE (inch/mm)	X LARGE (inch/mm)
A	Special	38.2 / 970	45.7 / 1161	51.2 / 1300	Special
B	Special	30.5 / 775	34.8 / 884	39 / 991	Special
C	Special	15.6 / 396	16.5 / 419	17.3 / 439	Special



HOYER® SLINGS

Deluxe Stand-Aid Sling

 SAFE WORKING LOAD: 440 lb / 200 kg	 DEPENDENCY: Dependent FIM 3-4
 ATTACHMENT: Loops 6-Point Spreader Bar	 MATERIAL OPTIONS: Polyester Disposable





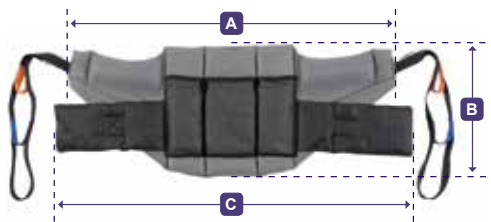

The Standing sling is suitable for those patients who have a greater degree of weight bearing ability. It allows good access for toileting and is easy to fit, providing quick and effective transfers. The adjustable waist strap and the non-slip back pad ensures a comfortable transfer.

AREA	X SMALL (inch/mm)	SMALL (inch/mm)	MEDIUM (inch/mm)	LARGE (inch/mm)	X LARGE (inch/mm)
A	Special	28.3 / 720	32.7 / 830	42.1 / 1070	Special
B	Special	12.2 / 310	13 / 330	13.4 / 340	Special
C	Special	29.1 / 740	35.4 / 900	48 / 1220	Special
Chest Strap Adjustment (maximum length)					
MAX	Special	40.1 / 1020	53.5 / 1360	61.4 / 1560	Special



*Also available in clip version

Deluxe Transport Sling

 SAFE WORKING LOAD: 440 lb / 200 kg	 DEPENDENCY: Dependent FIM 2-4
 ATTACHMENT: Loops 6-Point Spreader Bar	 MATERIAL OPTIONS: Polyester



This sling is suitable for those patients with a moderate degree of weight bearing ability. It is easy to fit, allowing quick and effective transfers. The adjustable waist strap and the non-slip back pad ensures a comfortable transfer.

AREA	X SMALL (inch/mm)	SMALL (inch/mm)	MEDIUM (inch/mm)	LARGE (inch/mm)	X LARGE (inch/mm)
A	Special	26.4 / 670	33.1 / 840	43.3 / 1100	Special
B	Special	11.4 / 290	13.4 / 340	15.7 / 400	Special
C	Special	33.9 / 860	39.8 / 1010	41.7 / 1060	Special
Chest Strap Adjustment (maximum length)					
MAX	Special	40.9 / 1040	51.6 / 1310	65 / 1650	Special



ABOUT HOYER® SLINGS

Sling Accessories



HEAD SUPPORTS AND PADS

- Help ensure correct positioning



SIDE SUSPENDERS

- Extends cradle for expanded sling comfort to the patient caused by pinching and squeezing



HEAD/NECK ROLL

- Provides additional comfort and support to the patient



EXTENSION STRAPS

- Allow an increase in length to the existing sling straps that connect to the lift



SLIDESHEETS

- Ultra-low friction allows basic patient handling tasks to be completed without the need to lift the patient

Prevent Program



25%

OF WORKERS
COMPENSATION CLAIMS
RESULT FROM IMPROPER
RESIDENT HANDLING*

48%

OF ALL OSHA REPORTED
NURSING HOME
INJURIES ARE DUE TO
OVEREXERTION**

\$12k

THE AVERAGE RESIDENT
HANDLING CAREGIVER
INJURY INDEMNITY*

Joerns Healthcare is more than a manufacturer and provider of state-of-the art beds, therapeutic surfaces and patient lifting equipment. We offer Prevent®, a professional services portfolio designed to assist caregivers with the ongoing clinical and operational challenges they face in delivering care. Prevent helps providers ensure alignment of their people, processes and products for superior outcome delivery.

Joerns Safe Patient Handling Mobilization Program

The Safe Patient Handling program was developed because we know that quality, well-designed equipment alone does not deliver an effective safe patient handling program. It is only one component of a comprehensive ergonomic program, which is why Prevent focuses on three core objectives:

1. Provide top quality equipment solutions
2. Safe patient mobilization policy developed by experts
3. Provide staff education and training on specific facility solutions

*Better Caregiver Morale,
Better Care Practice,
Better Compliance*



Why Prevent is important:

- Reduces caregiver injuries
- Patient safety/comfort focused
- Mitigates risk of falls
- Reduces PrU never events
- Cost reduction related to workers comp. And liability insurance.

How Prevent Creates a Safer Environment

- Identify risk factors
- Analyze the risk factors and decide where change is necessary
- Identify the solutions required
- Effectively implement the solutions into the environment
- Measure the success of solutions

*2012 Aon Health Care Workers Compensation Barometer

**LTC Magazine 4/18/2012

UNIQUELY SERVES THE CONTINUUM OF CARE

Hoyer® lifts and lifting systems offer the most across the care continuum



Joerns Healthcare

We understand the clinical and financial challenges acute care facilities face in improving care and patient experience, managing costs, increasing patient safety, and reducing on-the-job injury for staff, all while achieving optimal patient outcomes in an environment increasingly focused on value-based purchasing by payers.

Joerns Healthcare acknowledges these challenges by delivering quality specialty equipment and value-based solutions, clinical support, and staff training for all our equipment through our leading national and regional distribution partnerships.

Service Highlights

40,000+ Daily Patients	24/7/365 Service
<4 hrs. National Average Delivery	130+ Service Locations
JCAHO Accredited	120,000+ Items in Service
700+ Service Technicians	600+ Service Vehicles

Premium Products



Our Dolphin® brand of advanced therapeutic surfaces is becoming the first choice for critically compromised patients with tissue viability concerns.



Our Hoyer® brand is the oldest and most recognized brand name in patient handling.



Our P.R.O.® brand of hybrid surfaces has provided thousands of caregivers and patients with a clinically effective and cost-effective therapy surface.

Our People



The Purple Shirt is a unique and powerful part of our tradition of caring and corporate culture. Our success is embedded in our founding principle – maintaining an emotional, compassionate connection with customers that inspire associates to perform at exceptional levels.

People

We acknowledge that people are the heart of all that matters at Joerns Healthcare – our associates, our customers, and those they care for.

PEOPLE FIRST, CHARACTER, KNOWLEDGE

Passion

We will aggressively pursue innovative solutions with uncompromising vigor.

UNPARALLELED SERVICE, DEDICATION, TEAMWORK

Performance

We will bring to market high-quality, best value, integrated solutions that address the need of today and anticipate those of tomorrow.

PRODUCT SUPERIORITY, TOTAL QUALITY, PROFITABILITY



US Customer Care

General: 800.826.0270
Hospice: 800.528.1001

Customer Experience and Collaboration Center

2430 Whitehall Park Drive
Suite 100
Charlotte, NC 28273

Regional Collaboration Centers

19748 Dearborn Street
Chatsworth, CA 91311

2100 Design Road, Suite 100
Arlington, TX 76014

www.Joerns.com

Canada Customer Care

866.546.1151

Canada Office

35 Consortium Court
London, ON Canada
N6E 2S8

All Other Countries

+44 (0) 844.811.1156
+44 (0) 844.811.1157