

User Instruction Manual

Hoyer® Journey

To avoid injury, read user manual prior to use.

Manuel de l'utilisateur

Hoyer® Journey

Afin d'éviter tout accident, veuillez lire attentivement la notice avant utilisation.

Manual de Instrucciones

Hoyer® Journey

Para evitar posibles daños, lea previamente el manual de usuario.

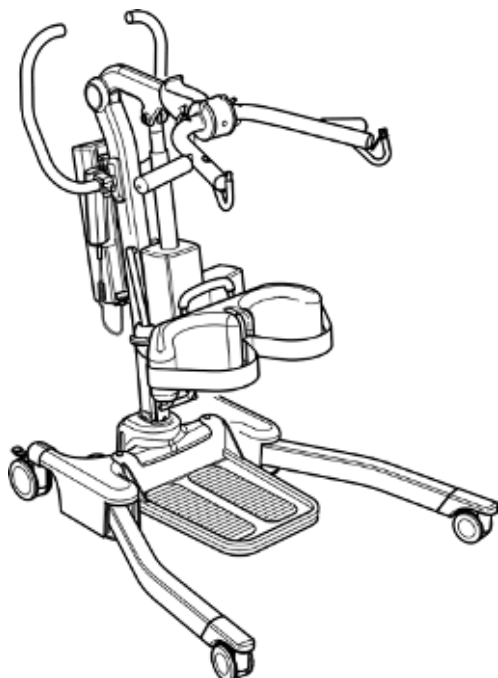

Contents

1. The Hoyer Journey Patient Lift.....	3
2. Introduction: About Your Lift	4
3. Assembly & Commissioning Instructions	5
4. Sling Guide.....	10
5. Lifting With Your Hoyer Journey.....	12
6. Standard Control Box & Handset	14
7. Smart Monitor & Handset.....	15
8. Operating Instructions	19
9. Safety Precautions	22
10. Charging Instructions.....	24
11. Maintenance Schedule & Daily Check List	26
12. Technical Specifications	28
13. Warranty	31

1. The Hoyer Journey Patient Lift

Ready for use position

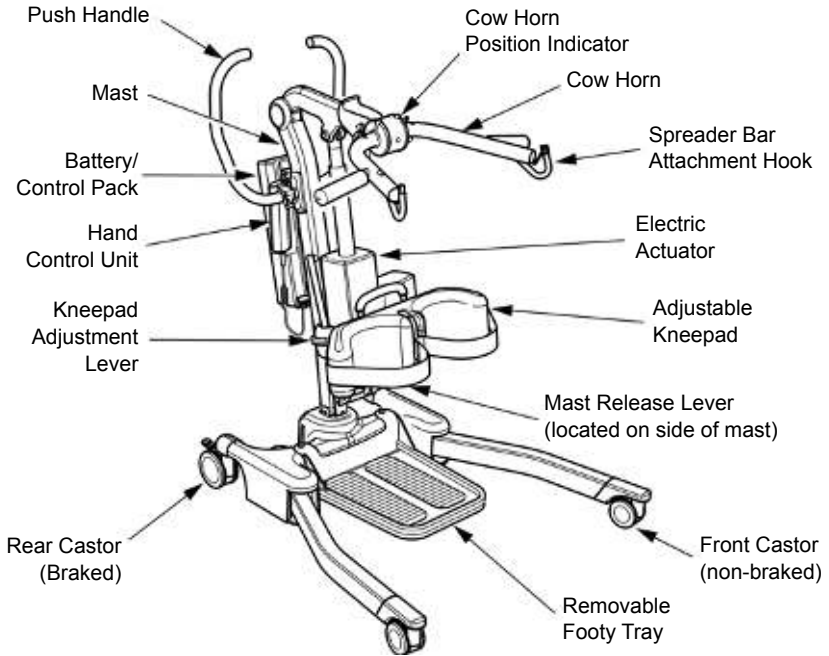

Storage position

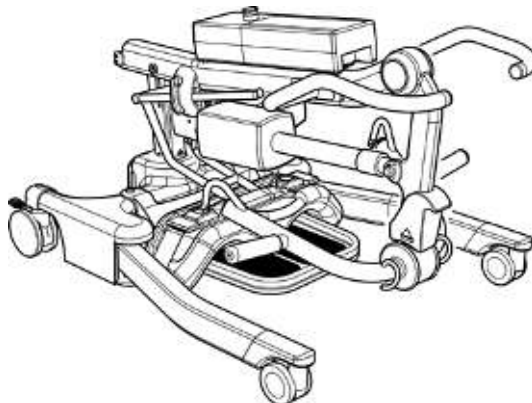

2. Introduction: About Your Lift

Each Journey lift is fully assembled, load tested and certified before being packed/shipped.

The packing consists of a strong, purpose built carton to ensure the safe arrival of the lift. A number of documents are supplied in a wallet, and packed with each lift and should be kept safely for future reference:

- TEST CERTIFICATE
- USER MANUAL

The TEST CERTIFICATE is an important document and should be kept for reference purposes.

To properly maintain your lift please refer to the maintenance schedule included in this document. If you are at all unsure what your country's servicing requirements are, please check with your dealer and/or a local government agency.

Statement of Intended Use (Journey)

The intended use of this lifting device is for the safe lifting and transfer of an individual from one resting surface to another (such as a bed to a wheelchair). Joerns Healthcare recommends that the transfer of a patient is fully risk assessed and conducted safely over a short distance only.

The Hoyer Journey is suitable for patients in the SITTING position only who have a degree of weight-bearing ability but require assistance to stand. By removing the foot tray, the Hoyer Journey patient lift can also be used as a walking aid following a careful risk assessment.

The Hoyer Journey is designed to support and promote safe patient handling and transfer for both the patient and carer. It can be folded without the use of tools enabling it to be easily stored in environments where space is limited or to facilitate onward transportation in a vehicle with a suitably sized trunk.

The Hoyer Journey stand aid is designed to be used in conjunction with the Hoyer range of slings. The examples of slings suitable for use with this device are listed as follows:

- Hoyer Standing Sling
- Hoyer Transport Sling

Expected Service Life

Hoyer Professional lifts are designed and tested for a minimum service life of ten (10) years, subject to the use and maintenance procedures stated in this manual. Use, other than in accordance with these instructions, may compromise service life.

3. Assembly & Commissioning Instructions

Carton Contents

Place the carton in a clear working area and open carefully. The carton contains:

- HOYER JOURNEY LIFT
- BATTERY PACK
- WALLET CONTAINING DOCUMENTS
- CHARGING LEAD
- HAND CONTROL
- DESK TOP CHARGER/STAND

⚠ WARNING

The Hoyer Journey is heavy and will need to be lifted with care. You may need assistance to lift the Hoyer Journey from the carton.

Assembly Instructions

The Hoyer Journey is delivered in its folded/storage position; the following assembly process demonstrates the 3 easy steps required to take the Hoyer Journey from its storage position to its ready for use position. This process is carried out with no additional tools required.

1. Remove all the parts from the carton and place on the floor, taking care to protect the finish from damage.

Lift the Hoyer Journey carefully from the carton. Lie the lift flat on the floor and ensure the rear castors are securely locked.

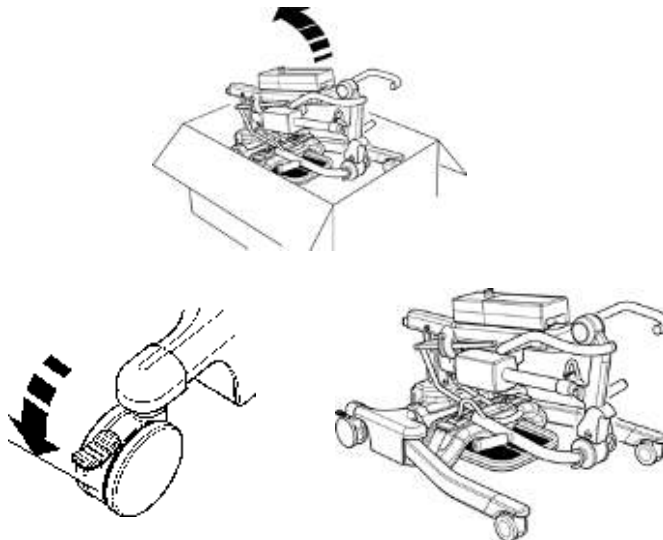

2. To unfold the Hoyer Journey into its ready-to-use position, raise the mast assembly upright. This is achieved by pressing the mast release button located under the actuator (as shown). This will release the mast assembly and allow the mast to be raised. Using the top of the push handle, raise the mast to its upright position and locate the mast into the slot (1). Once the mast is firmly located, use the mast locking lever to secure the mast. This is achieved by turning the mast lever clockwise to tighten and then pushing the mast locking lever down towards the mast surface (2). Finally, release braked castors at the rear and the Hoyer Journey is ready for use (3).

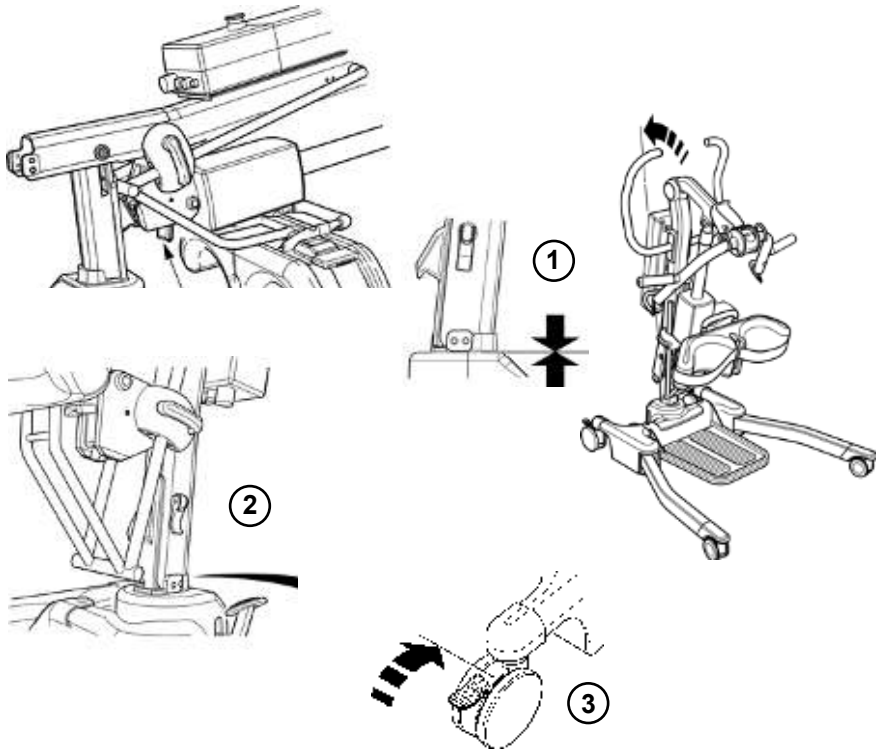

⚠ CAUTION

Avoid trapping fingers. Keep fingers away from the end of the mast when inserting into the mast slot. Tighten the mast-locking device, and unlock the braked castors at the rear.

3. Adjust the cow horn mechanism into one of three positions to suit either the patient task and/or environment. To adjust the cow horn, simply pull the trigger backwards towards the rear of the lift while holding the cow horn. Then select the desired position as indicated on the positioning decal (1) and release the trigger to lock. The lift is now ready for operation.

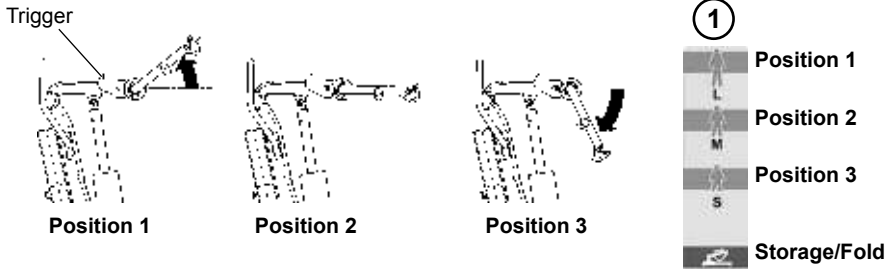

NOTE: See page 12 for cow horn position guidelines.

Disassembly

To disassemble and store the Hoyer Journey follow the four easy steps shown below; please note that no additional tools are required.

1. Lower the boom into its lowest possible position and adjust the cow horn to the storage/fold position (as shown).

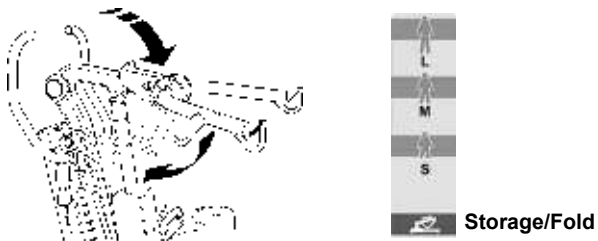

2. Ensure the rear castors are securely locked (1). Raise the knee pad to its upper most position (2).

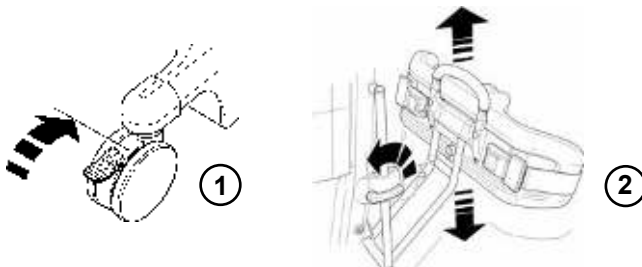

3. Unlock the mast-locking lever by pulling it outwards from the mast (1). Using the push handle lift the mast upwards and then slowly push downwards (2), carefully folding the mast assembly towards the legs until you hear a “Click” (3). The “Click” indicates the mast is now in its locked position.

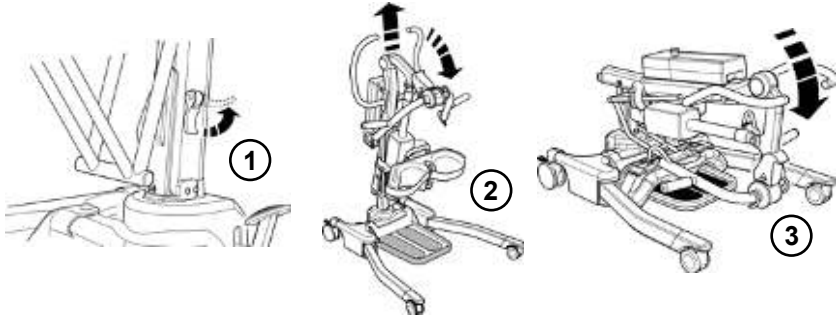

4. When folded, lift the Hoyer Journey upright using the legs and push handle as a guide.



NOTE: If you wish to separate the mast and boom completely from the base and legs, undo the mast-locking lever fully (remove pin assembly from mast) and lift the mast and boom completely free from the base. Be careful not to lose the mast lock lever and location spindle.

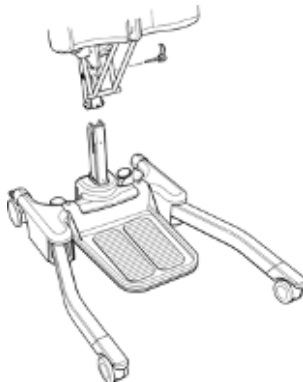

⚠ CAUTION

Care should be exercised when folding/unfolding the Hoyer Journey as there is a possible danger of trapping the fingers etc. Please follow the instructions carefully and ask for assistance if you are unsure of the correct procedure.

ALWAYS CHECK THE FOLLOWING BEFORE OPERATION:

- The mast is fully locked into position (see assembly instructions, page 6).

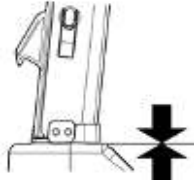

- The legs of the lift open and close freely (Using foot pedals).

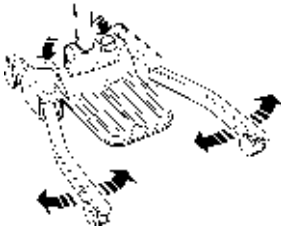

- The power pack is fitted to the lift and the latch holding the power pack in place is fully engaged. A "Click" should be heard when it is in place.



- The red emergency stop button, located on the control box, is in the RUN (out) position.



- The up and down buttons on the hand control lower and raise the boom correctly.

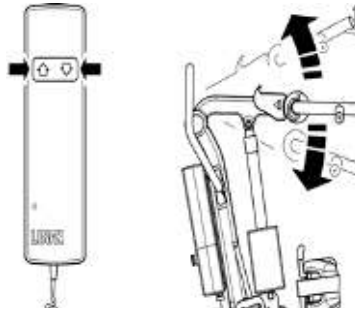

4. Sling Guide

The Hoyer Journey is suitable for patients in the SITTING position. The slings suitable for this device are listed as follows:

- * Hoyer Transport sling (various sizes available)
- * Hoyer Standing sling (various sizes available)

USER GUIDE FOR STANDAID SLINGS

Both the Transport and Standing sling are easy fit slings, suitable for standing and supporting. They are not a general purpose sling. Patients must always be assessed for suitability by a qualified person.

Transport Sling

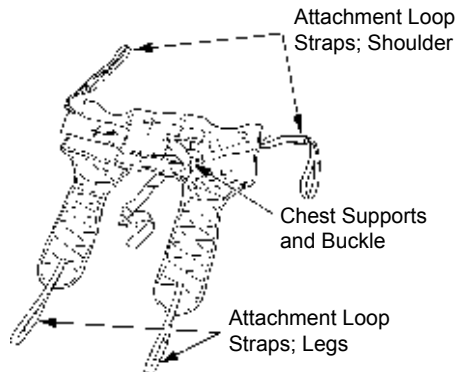

Fitting Instructions

Feed the sling down the back of the patient leaving the top of the commode aperture at the base of the spine. Check the roll part of the sling is square across the patient's back. Attach the support strap around the chest of the patient. This strap need not be tight. It is there to hold the sling in position while attaching the loops to the Standaid. It may be left off altogether if preferred. Ensure patient's arms are on the outside of the sling (refer to Fig. C, page 13).

Raise the patient's leg and feed the leg strap under and up between the legs. Ensure the sling is not twisted or creased under the thigh. Repeat this procedure for the other leg. Attach the loops on the roll parts of the sling to the white hooks at the end of the handgrips. Without crossing the loops on the leg straps, attach to left and right hooks on the lifting fork. You would normally use the middle of the three loops. The patient is now ready to be raised from the seat. Once clear of the seat, the patient will be more comfortable if lowered back in to the sitting position. Joerns Healthcare recommends that slings be checked regularly and particularly before use for signs of fraying or damage. Do not use slings that are worn or damaged.

Standing Sling

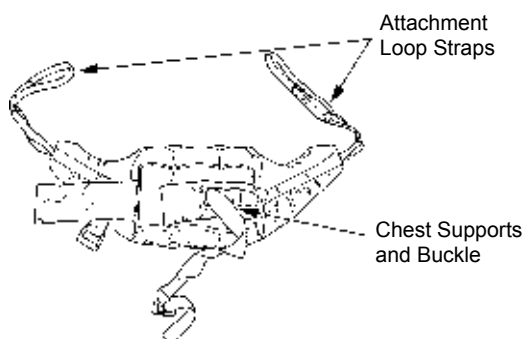

Fitting Instructions

Place the sling down behind patients back between base of shoulder blades and bottom of rib cage. Attach the support straps around the front of the patient. This strap need not be tight. It is there to hold the sling in position whilst attaching the sling to the Standaid. It may be left off altogether if preferred. Ensure that the patient's arms are outside the sling (refer to Fig. A, page 13).

NOTE: For detailed fitting instructions, please refer to the user guide supplied with each sling.

⚠ WARNING

Joerns Healthcare recommends that slings be checked regularly and particularly before use for signs of fraying or damage. **DO NOT** use slings that are worn or damaged.

⚠ WARNING

HOYER RECOMMENDS THE USE OF GENUINE HOYER PARTS. Hoyer slings and lifters are not designed to be interchangeable with other manufacturer's products. Using other manufacturer's products on Hoyer products is potentially unsafe and could result in serious injury to patient and/or caregiver.

⚠ WARNING

Refer to maximum weight capacity of lift. Sling capacity is limited by the maximum capacity of the lift.

5. Lifting With Your Hoyer Journey

The Hoyer Journey has an adjustable cow horn. This allows the carer to position the cow horn in a comfortable position to suit the patient or environment. The cow horn has 3 positions. Position 1 is more suitable for a large/taller patient, position 2 is more suitable for a medium/average size patient and position 3 is more suitable for a shorter/pediatric patient or when standing a patient from a low chair. (Please note, these are guidelines only, it may be necessary to adjust according to patient comfort). To adjust the cow horn, simply pull the trigger backwards towards the rear of the lift whilst holding the cow horn. Then select the desired position as indicated by the positioning decal and release trigger to lock. The cow horn has 3 alternative positions for lifting and a further one for the storage/fold position.

Cow Horn Lift Positions

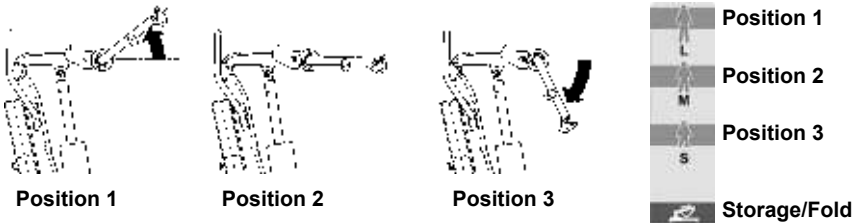

Lifting from a sitting position

Select the most suitable cow horn position to suit the patient or environment. Once complete, position the Standaid so that the patient's feet fit in the foot tray and the knees rest against the kneepad. The optimal position for the kneepad is just below the patella. Adjust the kneepad accordingly and fit the safety belt if required. If not required, the safety belt can be detached and stored away.

Attach the loops of the sling to the grey hooks at the end of the Hoyer Journey handgrips. The patient's hands should be placed on the handgrips (see Fig A or C). Prior to lifting make a visual check to ensure the loops of the sling are secure and in place. Then, push the UP button on hand control to raise the patient to the standing position (see Fig B or D).

Standing Sling:

Fig. A



Fig. B

Transport Sling:

Fig. C



Fig. D

NOTE: Joerns Healthcare recommends a risk assessment be completed before carrying out your lifting operation.

⚠ WARNING

If using the Hoyer Journey for gait training, the foot tray should be removed and a thorough risk assessment carried out to ascertain suitability prior to lifting.

6. Standard Control Box & Handset

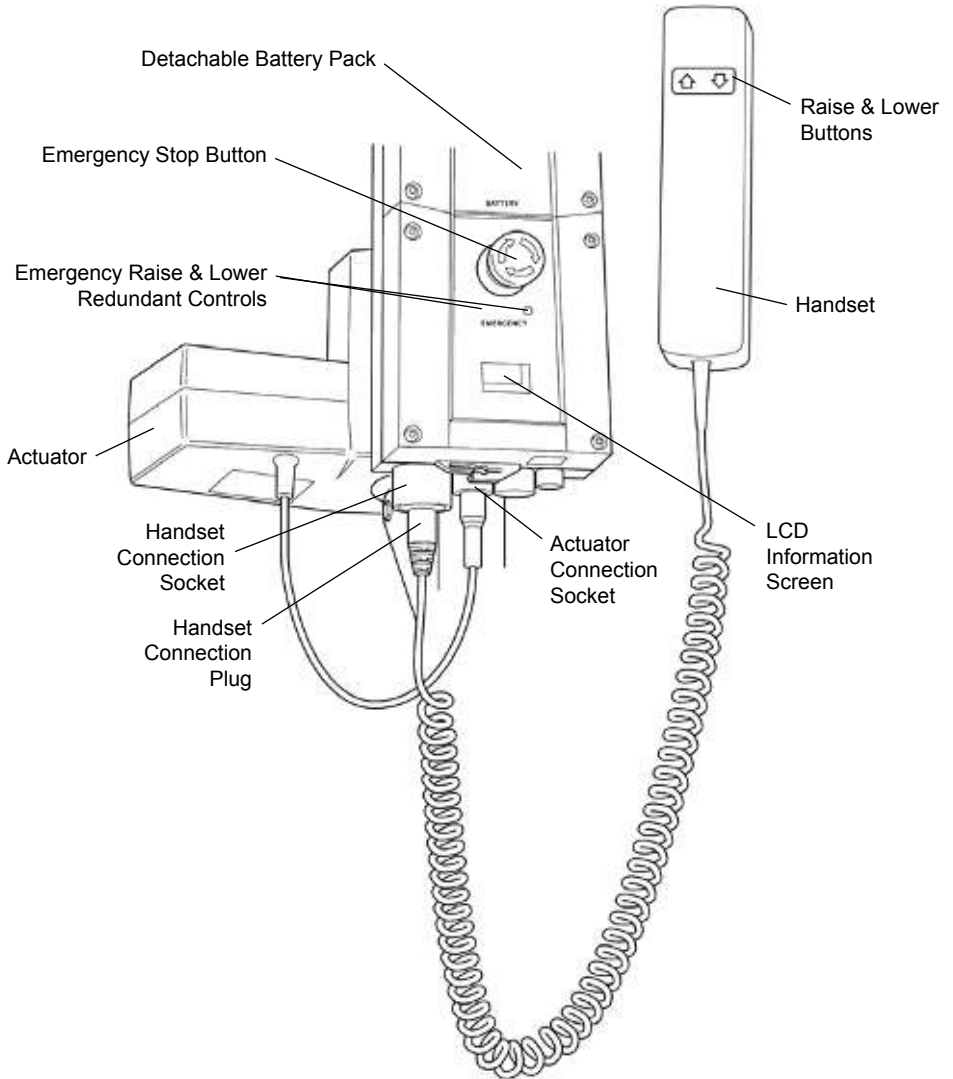

7. Smart Monitor & Handset

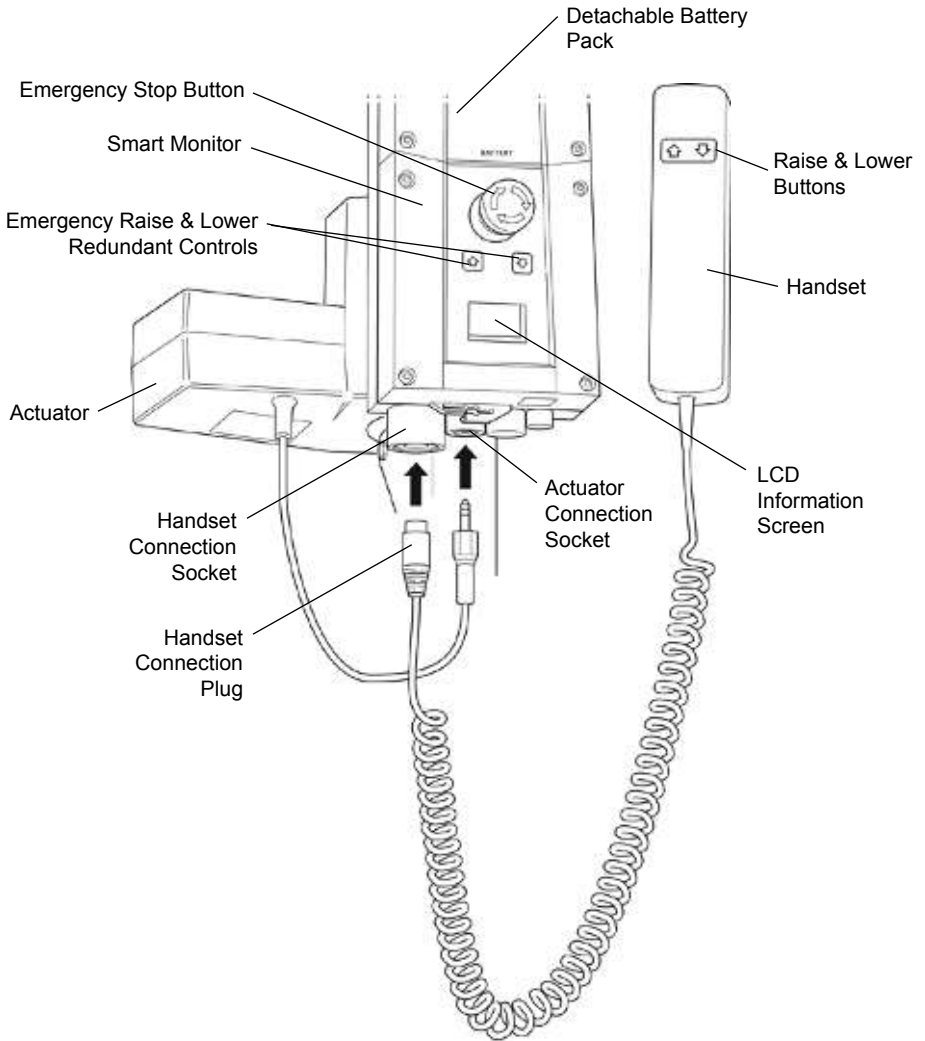

Intended Use

The Hoyer Smart Monitor is a control system for Hoyer Lifts. The Smart Monitor stores useful lift data about the lift that can be recalled when required. This lift data includes:

- Number of patient lift cycles
- Total work done by actuator
- Number of lift overloads (attempted lifts above the safe working load)
- Number of days in service

The Hoyer Smart Monitor contains a microprocessor inside making it possible to read out lift data via the on-board LCD screen.

Features

- Data collection in the control box with data display via LCD screen
- Work counter
- Intelligent cycle counter
- Overload information
- 3 step battery indicator



Benefits

- Improved safety for both patient and carer
- Accurate lift data available at the touch of a button
- Optimised product life time
- Ease of maintenance for engineers and service technicians
- Fast and easy error identification

LCD Display Screen

The Hoyer Smart Monitor has the option to read out information via the LCD display screen. It is possible to read out total lifting cycles, total work done, overloads and number of days since last service, which can be used to quickly and easily evaluate the condition of the lift actuator.

This information is accessed by a ½ second press on the 'UP' button on the User handset or redundant 'UP' button on the Smart Monitor.

	12034	— Total Lifting Cycles
A*S	1257000	— Total Work Done (Amps * Seconds)
	7	— Number of Overloads
	90/—	— Number of Days in Service

Service Information



If the lift stops because of an overload (an attempt to lift more than the safe working load) the overload symbol will appear on the LCD display and the lift will cease to operate until the additional load (above the SWL) has been removed.

WARNING

If the LCD display screen on your Smart Monitor has recorded an overload, Joerns Healthcare recommend that ALL routine daily checks are carried out on the lift prior to further use (for a list of daily checks, please refer to your lift user manual). Joerns Healthcare also recommend that you contact your authorised Hoyer service provider for additional guidance.

On-Board Redundant Controls

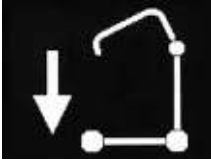

On-board redundant controls enable the lift to be raised or lowered in the event of an emergency.

Battery Information



The display showing full battery means that the battery is fully charged and the lift is ready for use.

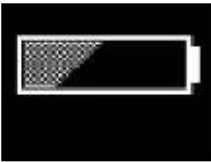

The display showing a half empty battery indicates that it is time to charge the battery.

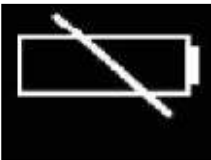

The empty battery symbol showing on the display indicates that the battery has no capacity left and should be placed on charge immediately.

⚠ WARNING

To avoid possible permanent damage to the battery, the battery should be placed on charge as soon as the display indicates the half empty battery symbol.

8. Operating Instructions

1. Leg Adjustment

The legs on the Hoyer Journey are adjustable for width. The legs can be opened to enable access around armchairs or wheelchairs. For transferring and negotiating narrow doorways/passages, the lift legs should be in the closed position. To achieve the adjustment, the leg adjuster pedal, located at the rear of the base, is compressed right (DOWN) to open the legs outwards and left (UP) to close the legs. The adjustment can be carried out with the patient in the lift, but whether loaded or unloaded the adjustment should be made when the lift is moving.

2. Castors and Braking

The lift has two braked castors, which can be applied for parking. When lifting, the castors should be left free and un-braked. The lift will then be able to move to its natural centre of gravity. If the brakes are applied, it is the patient that will swing to the centre of gravity and this may prove disconcerting and uncomfortable.

3. Raising & Lowering The Boom

A powerful electric actuator that is controlled by a simple hand control unit achieves the movement of the boom. The hand control has two buttons with directional arrows UP and DOWN ↑↓. The actuator stops automatically at its limit of travel in both directions. The hand control plugs into a socket at the base of the control box.

4. Emergency Stop

The red Emergency Stop Button is located on the front of the control box and is activated by pressing it in. This will cut all power to the lift and will only be reset by twisting the button clockwise and releasing.

5. Redundant controls

Standard Control Box:

The standard control box is fitted with emergency lower/raise buttons located underneath the emergency stop button. They can be operated by inserting the tip of a ball point pen into the buttons highlighted "lower/raise". This will raise or lower the boom should the hand control fail.

Smart Monitor:

The Smart Monitor is fitted with redundant raise and lower buttons on the control box. These are located underneath the emergency stop button and can be used to lower/raise the patient should the hand control fail.

6. Mechanical Emergency Down

In the case of a complete electrical failure the electrical actuator is fitted with a spring loaded mechanical lowering device (RED BOSS). This will only operate when the lift is under load. The device must be twisted by hand and released to activate. A slow decent will commence. Repeat this process until the patient has been safely lowered.

NOTE: The MINIMUM load required to manually lower the lift using the mechanical emergency down function is 30 kg.

7. Batteries

A LOW VOLTAGE ALARM protects the batteries from deep discharge. This will sound when the batteries need recharging and the hand control is being operated. It will not sound independently of the hand control being operated. **DO NOT IGNORE THIS WARNING ALARM.** Complete the lifting operation and place the battery on charge (see charging instructions). The battery charge level is displayed by the indicator on the control box.

⚠ CAUTION

The battery, charger, hand control, control box and actuator should not be opened by unauthorised personnel. (Contact your distributor for warranty and repairs).

8. Slings

The Hoyer Journey is suitable for patients in the SITTING, position. The slings suitable for this device are listed as follows:

- Hoyer Transport sling
- Hoyer Standing sling

9. Knee pad adjustment

The Hoyer Journey has an adjustable kneepad. It is recommended for safety and ergonomic reasons that any adjustment is carried out by holding the top of the adjustment handle. The range of travel is 10.2 inches (260mm). Adjustment is achieved by following two easy steps. STEP 1 turn the kneepad adjustment lever to the left to unlock. STEP 2 either push handle downwards or pull handle upwards to select correct position. Once the ideal position is found, simply turn the kneepad adjustment lever to the right to lock in place, NOTE: the lever can be operated from either side of the lift.

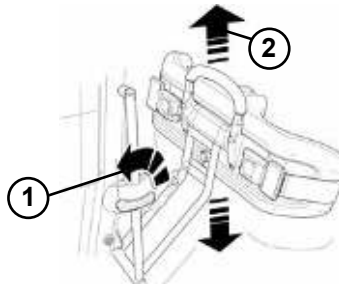

10. Removable footplate

The Hoyer Journey has a removable footplate. To remove the footplate, move to the front of the Hoyer Journey and lift the footplate upward from the middle of the base assembly.

NOTE: Be careful when removing the footplate from its low-seated position as it is heavy. Always use appropriate moving and handling techniques.

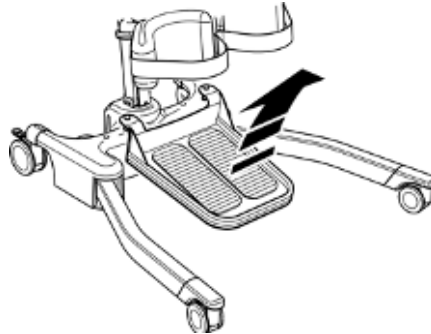

⚠ WARNING

If using the Hoyer Journey for gait training, the foot tray should be removed and a thorough risk assessment carried out to ascertain suitability prior to lifting.

11. Adjustable cow horn

The Hoyer Journey has an adjustable cow horn. This allows the carer to position the cow horn in a comfortable position to suit the patient or environment. The cow horn has 3 positions. Position 1 is more suitable for a large/taller patient, position 2 is more suitable for a medium/average size patient and position 3 is more suitable for a shorter/pediatric patient or when standing a patient from a low chair. (Please note, these are guidelines only, it may be necessary to adjust according to patient comfort). To adjust the cow horn, simply pull the trigger backwards towards the rear of the lift whilst holding the cow horn. Then select the desired position as indicated by the positioning decal and release trigger to lock. The cow horn has 3 alternative positions for lifting and a further one for the storage/fold position.

Trigger

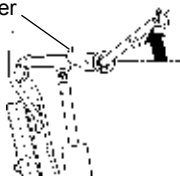

Position 1



Position 2



Position 3



Position 1

Position 2

Position 3

Storage/Fold

Cow Horn Lift Positions

9. Safety Precautions

Please read and follow the safety precautions listed below. The operation and use of Hoyer patient lifts is simple and straightforward. Following these few basic safety precautions will make lifting operations easy and trouble free.

READ AND UNDERSTAND THE USER INSTRUCTION MANUAL BEFORE USING YOUR Hoyer Journey

WARNING: Important safety information for hazards that might cause serious injury.

CAUTION: Information for preventing damage to the product.

NOTE: Information to which you should pay special attention.

WARNING

- **DO NOT** lift a patient unless you are trained and competent to do so.
- **ALWAYS** carry out the **DAILY CHECK LIST** located towards the end of the manual before using the lift.
- **DO NOT** exceed the safe working load of the lift.
- **ALWAYS** plan your lifting operations before commencing.
- **ALWAYS** familiarize yourself with the operating control and safety features of a lift before lifting a patient.
- **DO NOT** use a sling unless it is recommended for use with the lift.
- **ALWAYS** check the sling is suitable for the particular patient and is of the correct size and capacity.
- **NEVER** use a sling, which is frayed or damaged.
- **ALWAYS** fit the sling according to the instructions provided (user instructions).
- **ALWAYS** check the safe working load of the lift is suitable for the weight of the patient.
- **ALWAYS** carry out lifting operations according to the instructions in the user manual.
- **NEVER** disconnect or bypass a control or safety feature because it seems easier to operate the lift.
- **ALWAYS** lock the wheels when lifting from the floor.
- **DO NOT** attempt to manoeuvre the lift by pushing on the mast, boom or patient.
- **ALWAYS** manoeuvre the lift with the handle provided. A foot push pad is also provided.
- **DO NOT** push a loaded lift at speeds, which exceed a slow walking pace (2.6 ft/sec).
- **DO NOT** push the lift over uneven or rough ground. Particularly if loaded.
- **DO NOT** attempt to push/pull a loaded lift over a floor obstruction.
- **NEVER** force an operating/safety control. All controls are easy to use and do not require excessive force.

- **DO NOT** park a loaded lift on ANY sloping surface.
- **DO NOT** use electric lifts in a shower.
- **DO NOT** use or store a lift in a wet or corrosive environment such as shower, bath or pool locations.
- **DO NOT** charge batteries in a bathroom or shower room.
- **DO NOT** place or store batteries under direct sunlight or near a heat source.
- **YOUR** lift is for patient lifting. **DO NOT** use it, or allow it to be used, for any other purpose.
- **DO NOT** bump the lift down steps, loaded or unloaded.
- **DO NOT** attempt to negotiate a loaded lift on a slope, which exceeds 1:12 (approximately 5 degrees)
- **DO NOT** attempt to negotiate a slope without a second helper being present.
- **DO NOT** use a loaded lift on thick pile carpet.
- **NEVER** operate the lift with loose or missing parts or fasteners.
- **INSPECT** all precautionary labels on the lift. Order and replace all labels that cannot be easily read.

10. Charging Instructions

When the power pack needs charging it is removed from the lift and fitted to an off board charging unit.

Joerns Healthcare recommend an additional battery pack is purchased, so that one pack can be on charge at all times.

1. Remove the power pack from the lift. The pack is retained by a simple latch at the top of the power pack. Lift the latch and the power pack will be released.
2. Fit the power pack to the charging unit. The location and latching of the power pack to the charger is the same system as used on the lift.
3. Plug the charger mains plug into a suitable mains outlet and switch the mains supply ON.
4. Charging is automatic and will fully charge the batteries over a period of four (4) hours.
Note: Even if the charger is left plugged in for extended periods it will not allow the batteries to overcharge.
 - a) Green Light - Indicates main power is on.
 - b) Yellow Light - Indicates battery is charging.
 - c) Battery will be fully charged when yellow light goes off.
Note: It is recommended that the battery be charged immediately upon receipt.
5. To return the lift to service, switch OFF the mains supply and remove the power pack from the charger. Fit the power pack to the lift and make sure the latch holding the pack in place is fully engaged. "Click" in place. The charging of Hoyer electric lifts is simple and straightforward, but it is important to follow the charging instructions closely. Please pay particular attention to the following points, they will help you avoid problems with discharged batteries.

WARNING

- **The battery, charger, hand control & control box are NOT to be opened by unauthorised personnel. (Contact your distributor for warranty and repairs).**
- **DO NOT touch battery/charger terminals.**
- **KEEP the batteries fully charged. Place the battery on charge whenever it is not in use. If it is more convenient to do so, place on charge every night. The charger will not allow the batteries to overcharge.**
- **NEVER run the batteries completely flat. As soon as the audible warning sounds, complete the lifting operation in hand and place on charge.**
- **To avoid possible permanent damage to the battery, the battery should be placed on charge as soon as the display indicates the half empty battery symbol.**
- **NEVER store the battery for long periods without regular charging throughout the storage period.**
- **ALWAYS make sure the mains power to the charger is switched off before connecting or disconnecting the battery pack.**
- **NEVER leave the battery pack connected with the charger mains power switched off.**

- **DO NOT** leave the charger switched on with the battery disconnected.
- **DO NOT** use the lift while charging is taking place.
- **CHECK** the lift is not charging before moving as the electrical connection may be damaged.
- **NEVER** disconnect the charger plug by pulling on the cable.
- **BE CAREFUL** not to trip over the charge lead.
- **DO NOT** charge an electric lift in a bathroom or shower room.

11. Maintenance Schedule & Daily Check List

All Hoyer products are designed for minimum maintenance, however some safety checks and procedures are required. Schedules of DAILY tasks are detailed below. Daily checks and a yearly service, inspection and test will ensure a lift is kept in optimum safe working condition. A list of spare parts is available upon request.

DAILY CHECK LIST:

Joerns Healthcare strongly recommends the following checks be carried out on a daily basis and before using lift.

- MAKE sure the lift moves freely on its castors.
- EXAMINE the spreader bar (cow horns) is firmly attached to the boom.
- EXAMINE the sling hooks and attachment clips on the spreader bar and boom for excessive wear.
- MAKE sure the legs open and close correctly.
- OPERATE the hand control to confirm the boom raises and lowers satisfactorily.
- CHECK the operation of the emergency stop button.
- EXAMINE slings for fraying or other damage. DO NOT use any sling if damaged.
- CONFIRM the lift is not giving a low battery alarm when the hand control is operated. If the alarm sounds, DO NOT use and place the battery on charge immediately.

MAINTENANCE:

Joerns Healthcare recommends regular inspection and maintenance. Please refer to the chart on the next page.

***THESE CHECKS SHOULD INCLUDE:**

✓ = Recommended

	Initially	Before Use	Annual Service
1. BOOM: Check the attachment of the boom to the mast. Make sure there is only minimal side movement of the boom and the boom is free to rotate on the boom bearing.	✓	✓	✓
2. SLING ATTACHMENT POINTS: Examine the sling hooks and attachment clips on the spreader bar and boom for excessive wear.	✓	✓	✓
3. MAST: Check the operation of the mast-locking device. Make sure the mast fully engages into the socket.	✓	✓	✓
4. COW HORN: Check cow horn is engaged and in correct position.	✓	✓	
5. ACTUATOR: The actuator should require no maintenance other than checking for correct operation and listening for unusual noise.	✓		✓
6. KNEE PAD: Check knee pad adjuster is fastened securely.	✓	✓	
7. CONTROL BOX / SMART MONITOR: Check the function of the emergency stop button. Inspect the hand control socket for correct fitting. Check functioning of the hand control. Check the redundant controls and confirm they operate as intended.	✓	✓	✓
8. BATTERIES: The batteries are housed in the power pack and should not require maintenance other than the regular charging as detailed in the charging instructions. Check that the connections remain clean.			✓
9. BATTERIES (Charging): Confirm the lift is not giving a low battery alarm when the hand control is operated. If the alarm sounds, do not use and place the battery on charge immediately.	✓	✓	
10. LEG ADJUSTMENT: Check the legs operate in both full extensions (inward/outward).	✓		✓
11. CASTORS: Check all castors for firm attachment to the legs. Check for free rotation of the castor and the wheels.	✓	✓	✓
12. CLEANING: Clean with ordinary soap and water and/or any hard surface disinfectant. Harsh chemical cleaners or abrasives should be avoided as these may damage the surface finish of the lift. Avoid wetting any of the electrical parts.		✓	✓
13. BASE AND WHEELS: Ensure base is even and level (all four wheels are on the floor).	✓	✓	✓
14. SLINGS: Check for wear and fraying.	✓	✓	✓
15. LUBRICATION: Lubricate pivot joints with a silicone based oil, including mast and boom connections, pedal assembly, spreader bar joint (only if required).			✓
16. HAND SET: Ensure plugged fully into controller.	✓	✓	
17. HARDWARE: Check all nuts, bolts, screws and fasteners for excessive wear and for tightness. Replace as required.		✓	✓

12. Technical Specifications

Safe Working Load	341 lbs.....	155 kgs
Maximum Overall Length	39.4 inches.....	1000 mm
Minimum Overall Length	36.8 inches	935 mm
Maximum Overall Height.....	63 inches	1600 mm
Minimum Overall Height.....	44.5 inches	1130 mm
Maximum Height to attachment point.....	60.2 inches	1530 mm
Minimum Height to attachment point.....	28.4 inches	720 mm
Turning Radius	45.1 inches.....	1145 mm
Legs Open - External Width	38.2inches	970 mm
Legs Open - Internal Width	34.5 inches	875 mm
Legs Closed - External Width	27.0 inches	685 mm
Legs Closed - Internal Width	22.2 inches	590 mm
Widest Point (between support handles)	26.8 inches	680 mm
Overall Height of Legs.....	4.3 inches	110 mm
Ground Clearance.....	1.2 inches	30 mm
Front Twin Castors	3.0 inches	75 mm
Rear Braked Castors.....	4.0 inches	100 mm

Weights

Mast, Base & Boom Assembly.....	82.4 lbs.....	37.4 kg
Power Pack	6.2 lbs.....	2.8 kg
Total	88.6 lbs.....	40.2 kg
Base Assembly (not inc battery).....	30.2 lbs.....	13.7 kg
Mast & Boom (not inc battery)	42.3 lbs.....	19.2 kg
Foot Tray	9.9 lbs.....	4.5 kg

NOTE: Manufacturing tolerances apply to all dimensions.

ELECTRICAL SPECIFICATIONS:

BATTERIES	24 volt Rechargeable sealed lead acid type
BATTERY CAPACITY.....	3.2 Ampere hours
CHARGER RATED INPUT.....	100 - 240 V AC/ 50/60 Hz
CHARGER RATED OUTPUT.....	29.5 VDC, Max. 19 W

ELECTRIC SHOCK PROTECTION

CHARGER.....	CLASS II (EN 60601-1)
LIFT	INTERNAL POWER SOURCE

DEGREE OF SHOCK PROTECTION

CHARGER.....	TYPE B (EN 60601-1)
LIFT	TYPE B (EN 60601-1)

ENVIRONMENTAL CONDITIONS:

Outside this environment functionality and safety may be compromised.

OPERATING:

TEMPERATURE	5°C to 40°C
RELATIVE HUMIDITY	20% to 90% @ 30°C - not condensing
ATMOSPHERIC PRESSURE.....	700 to 1060 hPa

STORAGE:

TEMPERATURE	-10°C to +50°C
RELATIVE HUMIDITY	20% to 90% @ 30°C - not condensing
ATMOSPHERIC PRESSURE.....	700 to 1060 hPa

IP RATINGS

CONTROL BOX	IPX4
ACTUATOR	IPX4
OFF BOARD CHARGER	IPX5
BATTERY	IPX5
HANDSET	IPX5

DUTY CYCLES

ACTUATOR	10% (2 min./18 min.)
CHARGER	Approx. 4 hrs.

ACOUSTICS

A-Weighted sound power level	60 dB (A)
------------------------------------	-----------

KEY SYMBOLS:

The following symbols are used on the charger, control unit and battery:



Type B equipment, as per EN 60601-1



Class 2 equipment



The disposal of the charging and control unit should not be mixed with general household waste



The disposal of batteries should not be mixed with general household waste.



The disposal of electronics should not be mixed with general household waste



For indoor use



ATTENTION, consult accompanying documents.

WEEE Producers registration number WEE/GG0464RZ

13. Warranty

This warranty covers HoyerPro lifts only. Lifts not covered under this warranty include, but are not limited to Advance-H, HML400, HPL600WB, HPL600WBSC, HPL402, C-HLA (and variations).

HoyerPro lifts are guaranteed for a period of two years from the date of delivery against defects in materials and workmanship under normal use and service. This warranty includes all mechanical and electrical components.

Aluminium structural components and mechanical components on lifts are covered under warranty for a period of five (5) years from the date of delivery.

Damage caused by use in unsuitable environmental conditions or failure to maintain the product in accordance with user and service instructions is not covered. Any alteration, modification or repair unless performed by or authorized in writing by Joerns Healthcare will void this warranty.

Parts:

HoyerPro lifts contain various parts that wear from normal use. These parts, such as DC batteries and casters are not covered under the two-year warranty but are covered for 90 days after date of delivery.

Joerns Healthcare's obligation under this warranty is limited to supplying replacement parts, servicing or replacing, at its option, any product which is found by Joerns Healthcare to be defective.

Warranty replacement parts are covered by the terms of this warranty until the product's original warranty period expires.

When requested by Joerns Healthcare, parts must be returned for inspection at the customer's expense. Credit will be issued only after inspection.

Service:

Most service requests handled by the facility Maintenance Department with assistance from the Joerns Healthcare Product Service Department.

Most parts requested can be shipped next day air at the customer's expense.

Should a technician be required, one will be provided by Joerns Healthcare, at our discretion. Only the Joerns Healthcare Product Service Department can dispatch authorized technicians.

This warranty is extended to the original purchaser of the equipment.

