



Mark For: Date: _____ Dealer Acct #: _____ Dealer: _____ Dealer Contact: _____ Dealer Address: _____ Dealer City: _____ PV: _____ PC: _____ Dealer Phone: () _____ Fax: () _____ Confirmation Email: _____ Confirm Via: <input type="checkbox"/> Fax <input type="checkbox"/> Email	Submitting for: <input type="checkbox"/> Quote <input type="checkbox"/> Order PO#: _____ <p style="text-align: center;">ADDITIONAL SHIPPING INFORMATION</p> Ship To: _____ Attention: _____ Address: _____ Address: _____ Ship To City: _____ PV: _____ PC: _____ Ship To Phone: () _____ Fax: () _____
---	--

✓ Option #	Definition	Price	✓ Option #	Definition	Price
------------	------------	-------	------------	------------	-------

Base Model			
<input type="checkbox"/>	194WM77	Quickie SR45	\$3,244.00

Power Tilt			
<input type="checkbox"/>	194PA53	Power Tilt (W/ Attendant & Tilt Cntrl) Tilt Control mounts to armrest <input type="checkbox"/> Left <input type="checkbox"/> Right (Rear Facing)	\$3,152.00

Frame Options			
<input type="checkbox"/>	194FO3	Standard Base and Seat Frame Maximum Weight: 265 lbs.	NC

Transit			
<input type="checkbox"/>	194TO38	Transit Option	NC

Tilt Release			
<input type="checkbox"/>	194TT12	Backrest Dual Trigger Cable Release (N/A w/ Power Tilt)	NC
<input type="checkbox"/>	194TT13	Foot Tilt Release - Mounted on Right Side of frame (N/A w/ Power Tilt)	\$59.00

Tilt Angle			
<input type="checkbox"/>	194TA2	0° to 45°	NC



Quickie SR45 shown with the JAY© J3™ backrest and JAY© 3™ cushion.



Quickie SR45 features IRIS™ (Intelligent Rotation In-Space) technology.

2. SIZE / SEATING

Frame Width			
<input type="checkbox"/>	194W5	14"	NC
<input type="checkbox"/>	194W6	15"	NC
<input type="checkbox"/>	194W7	16"	NC
<input type="checkbox"/>	194W8	17"	NC
<input type="checkbox"/>	194W9	18"	NC
<input type="checkbox"/>	194W10	19"	\$296.00
<input type="checkbox"/>	194W11	20"	\$296.00

Seat Type			
<input type="checkbox"/>	194ST35	Standard Seat Pan	\$169.00
<input type="checkbox"/>	194ST7	Omit Seat Pan	NC

JAY Cushions (Optional)			
<i>To order any JAY cushions on-chair, please see the JAY price list.</i>			
<i>Cushion name or part number must be filled out with desired width and depth</i>			
<input type="checkbox"/>	194JC20	JAY Bundled Cushion Cushion Name or Part #	Price List
		Width: _____ Depth: _____	

Frame Depth Set Up (Fill out either A or B)			
A. Setup By QUICKIE		B. Setup By DEPTH	
A. Desired Seat Depth		B. Frame Depth Range	
See Figure 1 for pricing, Figure 2 , Dimension A for measurement			
<input type="checkbox"/>	194SD7	14"	NC
<input type="checkbox"/>	194SD8	15"	NC
<input type="checkbox"/>	194SD9	16"	NC
<input type="checkbox"/>	194SD10	17"	NC
<input type="checkbox"/>	194SD11	18"	NC
<input type="checkbox"/>	194SD12	19"	\$296.00
<input type="checkbox"/>	194SD13	20"	\$296.00
<input type="checkbox"/>	194SD14	21"	\$296.00
<input type="checkbox"/>	194SD33	22"	\$296.00
A. User's Seated Height		B. Frame Depth	
See Figure 2 , Dimension B. Distance from seat surface to top of the head.			
<input type="checkbox"/>	194SJ01	Less than 37"	NC
<input type="checkbox"/>	194SJ02	37" or Greater	NC
		14" recommend short seat frame	NC
		15" recommend short seat frame	NC
		16" recommend short seat frame	NC
		17" recommend short seat frame	NC
		18" recommend medium seat frame	NC
		19" recommend medium seat frame	NC
		20" recommend long seat frame	NC
		21" recommend long seat frame	NC
		22" recommend long seat frame	NC

Figure 1

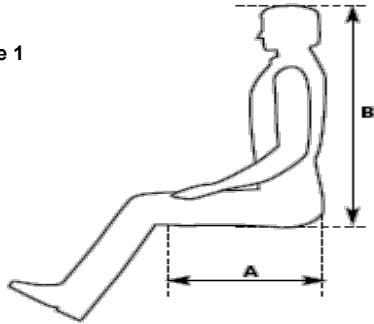

A. Top of Cushion to Seat Rail

See **FIGURE 3** Dimensions A & B. This measurement is taken from the top of the cushion to the upper surface of the seat rail. If the cushion has a wedged shape and/or has significant lateral pelvic contour, then determine the height of the cushion at the point where the ischial tuberosities would contact (not immerse) the cushion surface.

<input type="checkbox"/>	194CJ04	2 1/2" or Greater	NC
<input type="checkbox"/>	194CJ05	Less than 2 1/2"	NC
<input type="checkbox"/>	194CJ03	Below Seat Rail	NC

Figure 3

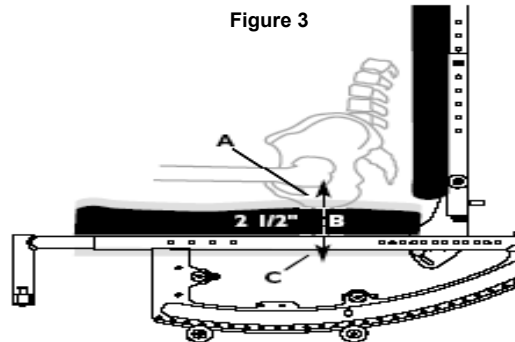

3. CASTERS / SEAT HEIGHT

Rear Wheel Size	CASTER SIZE					
	□ 4	□ 5	□ 6	□ 8x1	□ 8x1.5	□ 8x2
□ 12"	□ 16.0	□ 16.0				
	□ 16.5	□ 16.5				
	□ 17.0	□ 17.0				
	□ 17.5	□ 17.5	□ 17.5	□ 17.5	□ 17.5	□ 17.5
□ 12" Low Poly	□ 15.0					
	□ 15.5	□ 16.0				
	□ 16.0	□ 16.5				
	□ 16.5	□ 17.0				
□ 16"	□ 14.0	□ 15.0				
	□ 15.0	□ 17.0	□ 17.0			
	□ 17.5	□ 17.5	□ 17.5	□ 17.5	□ 17.5	□ 17.5
	□ 18.0	□ 18.0	□ 18.0	□ 18.0	□ 18.0	
	□ 18.5	□ 18.5	□ 18.5	□ 18.5	□ 18.5	□ 18.5
				□ 19.0		
□ 20"	□ 16.0	□ 16.0				
	□ 16.5	□ 16.5				
	□ 17.0	□ 17.0		□ 17.5		
	□ 17.5	□ 17.5	□ 19.5	□ 20.0	□ 17.5	□ 17.5
		□ 19.5	□ 20.0	□ 20.5	□ 19.5	
□ 22"	□ 16.5	□ 16.5				
	□ 17.0	□ 17.0		□ 17.5		
	□ 17.5	□ 17.5	□ 17.5	□ 18.0	□ 17.5	
	□ 18.0	□ 18.0	□ 18.0	□ 18.5		
□ 24"	□ 17.5	□ 17.5	□ 17.5	□ 18.0		
	□ 18.0	□ 18.0	□ 18.0	□ 18.5	□ 17.5	
	□ 18.5	□ 18.5	□ 18.5	□ 19.0	□ 18.5	
	□ 19.0	□ 19.0	□ 19.0	□ 19.5		

Casters			
□	194CW73	4" x 1.25" Semi Pneumatic	NC
□	194CW5	5" Low Profile Polyurethane	NC
□	194CW7	5" X 1.5" Semi Pneumatic	\$105.00
□	194CW34	6" Polyurethane	NC
□	194CW35	6"x 1.5" Semi Pneumatic	\$105.00
□	194CW32	8" Polyurethane	NC
□	194CW39	8"x 1.5" Semi Pneumatic	\$140.00
□	194CW36	8"x 2" Pneumatic	\$237.00
□	194CW100	8"x 2" Pneumatic w/Insert	\$378.00

4. REAR WHEELS / SEAT HEIGHT

Rear Wheel			
□	194RW13	12" Mag Wheel	NC
□	194RW14	16" Mag Wheel	NC
□	194RW3	20" Mag Wheel	NC
□	194RW8	22" Mag Wheel	NC
□	194RW1	24" Mag Wheel	NC

Rear Wheel Tire			
□	194RT3	Full Polyurethane <i>N/A with 12" and 16"</i>	NC
□	194RT4	Low Polyurethane <i>Only available with 12" Mag Wheel</i>	NC
□	194RT1	Pneumatic	NC
□	194RT2	Pneumatic Airless Insert	\$237.00

Handrim			
<i>12" and 16" wheels not available with handrims.</i>			
□	194HR1	Aluminum Anodized	NC
□	194HR4	Plastic Coated	\$140.00
□	194HR7	Omit Handrim	-\$12.00

Axle			
□	194AX1	Quick Release	NC
□	194AX44	Threaded	NC

5. WHEEL LOCKS

Wheel Lock			
□	194WL8	Push To Lock	NC
□	194WL43	Rear Foot Operated Wheel Lock	\$86.00
□	194WL10	Omit Wheel Lock	NC

Wheel Lock Extension Handle			
<i>Not available with rear foot operated wheel lock</i>			
□	194EH7	Extension Handle (Pair)	\$70.00

✓ Option # Definition Price ✓ Option # Definition Price

6. HANGER AND FOOTREST

Hanger			
<i>Front mount hangers only available w/ Alum angle adj footplates</i>			
<input type="checkbox"/>	194H139	70° Swing In/Swing Out -Ext. Mount	NC
<input type="checkbox"/>	194H140	70° Swing In/Swing Out -Front Mount	NC
<input type="checkbox"/>	194H141	80° Swing In/Swing Out -Ext. Mount <i>N/A with all 8" casters</i>	NC
<input type="checkbox"/>	194H142	80° Swing In/Swing Out -Front Mount	NC
<input type="checkbox"/>	194H159	Articulating Hanger <i>N/A w/ Platform Flip Up and Alum Angle Adj Front Mount footplates.</i>	\$397.00
<input type="checkbox"/>	194H160	Elevating Hanger - Ext Mount <i>N/A w/ Platform Flip Up and Alum Angle Adj Front Mount footplates.</i>	\$338.00
<input type="checkbox"/>	194H161	Elevating Hanger - Front Mount <i>Only available w/ front mount alum angle adj footplates and 14"-22" width</i>	\$338.00
<input type="checkbox"/>	194H144	Omit Hanger	NC

Articulating / Elevating Hanger Cover			
<input type="checkbox"/>	194DI47	Neoprene Cover	\$365.00
<input type="checkbox"/>	194DI48	Gel Pad Cover	\$429.00

Extension Tube (NA w/ Front Mount Hangers)			
<i>See lower leg length matrix</i>			
<input type="checkbox"/>	194E1	Short (N/A with ELR)	NC
<input type="checkbox"/>	194E2	Medium	NC
<input type="checkbox"/>	194E5	Long	NC

Lower Leg Length Range Matrix					
Hanger	Ext Tube	Footplate			Min Allowable FSH
		Extension Mount			
		Composite	Alum Angle Adj	Aluminum	
70° Swing In/Out	Short	10.0" - 14.0"	10.2" - 14.1"	NA	10 1/2
	Medium	11.0" - 15.9"	11.1" - 16.0"	NA	12
	Long	12.9" - 17.8"	13.0" - 17.9"	NA	14
80° Swing In/Out	Short	9.9" - 11.0"	10.1" - 13.7"	NA	10
	Medium	11.0" - 15.5"	11.1" - 15.7"	NA	10
	Long	12.7" - 17.3"	12.9" - 17.4"	NA	11 1/2

All values are ± 0.25" and based on flat seat heights and do not account for the minimum 2" ground clearance or footplate thickness. Full range not available with all seat heights. ELR measurements taken with ELR fully

Front Mount Extension Tubes (NA w/ Extension Mount Hangers)			
<i>Optional, not required for Front Mount Hangers</i>			
<input type="checkbox"/>	194E23	2"	\$51.00
<input type="checkbox"/>	194E24	4" <i>N/A w/14", 15" Seat To Floor Ht, N/A w/80° Hangers & 8" casters</i>	\$51.00

Hanger Mount			
Ext	None	2"	4"
70°	3.1" - 8.8"	3.1" - 11.1"	3.1" - 13.0"
80°	3.3" - 9.2"	3.3" - 11.7"	3.3" - 13.7"
90°	2.7" - 8.7"	2.7" - 11.2"	2.7" - 13.2"

Hanger Mounts			
<i>Possible interference with 80° & 90° hangers</i>			
<input type="checkbox"/>	194MZ02	Standard Hanger Mount	NC
<input type="checkbox"/>	194MZ01	1" Offset Hanger Mount	NC

Footplates			
<i>Heel loop not included, see Footplate Options section below</i>			
<input type="checkbox"/>	194F1	Composite	NC
<input type="checkbox"/>	194F5	Aluminum <i>Only Avail w/ Elevating Legrest</i>	NC
<input type="checkbox"/>	194F291	Aluminum Angle Adjustable	\$169.00

Footplate Options			
<input type="checkbox"/>	194HL1	Heel Loops	NC
<input type="checkbox"/>	194SA02	Toe Loops (pair) <i>Only Avail w/ Angle Adj. Footplate</i>	\$41.00

Hanger	Extension	Seat Sling to Top of Footrest		Min Allowable FSH
		Min	Max	
ALR	Short	8 1/2	16	10 1/2
	Med	10	18	12
	Long	12	20	14
ELR Ext. Mount	Short	8	14 1/2	10
	Med	8	16 1/2	10
	Long	9 1/2	18 1/2	11 1/2
ELR Front Mount	No Ext (top hole)	3 1/2	7 1/2	5 1/2
	2" ext tube	7 1/4	10 1/4	9 1/4
	4" ext tube	9 1/4	12 1/4	11 1/4
	6" ext tube	11 1/4	14 1/4	13 1/4

7. BACKREST / SEATING

Backrest Type			
<input type="checkbox"/>	194BT3	Non Folding Backrest <i>N/A with Height Adjustable Back</i>	NC
<input type="checkbox"/>	194BT99	Folding Backrest <i>N/A with Reclining Backrest</i>	NC

Backrest Options			
<input type="checkbox"/>	194OD19	Removable Extension <i>N/A with Height adj. back with adjustable stroller handle.</i>	\$169.00

Backpost Style - Select only one option within A, B, or C

A. Stroller Handle Backpost (Fixed)			
<i>Folding Backrest adds 1" to the listed values.</i>			
<input type="checkbox"/>	194BP48	Low (18")	NC
<input type="checkbox"/>	194BP49	Medium (21")	NC
<input type="checkbox"/>	194BP50	Tall (24")	NC

JAY J3 Back			
<input type="checkbox"/>	194JB01	JAY J3 Back	See OF

OR			
B. Height Adjustable Back w/ Adj. Stroller Handles			
<input type="checkbox"/>	194BP51	Standard 15"-21"	NC
<input type="checkbox"/>	194BP52	Tall 18"-24"	NC

OR			
C. Reclining Backrest			
<i>Not available with 22" Deep Frame</i>			
<input type="checkbox"/>	194BP53	Medium (21")	\$1,509.00
<input type="checkbox"/>	194BP54	Tall (24")	\$1,509.00

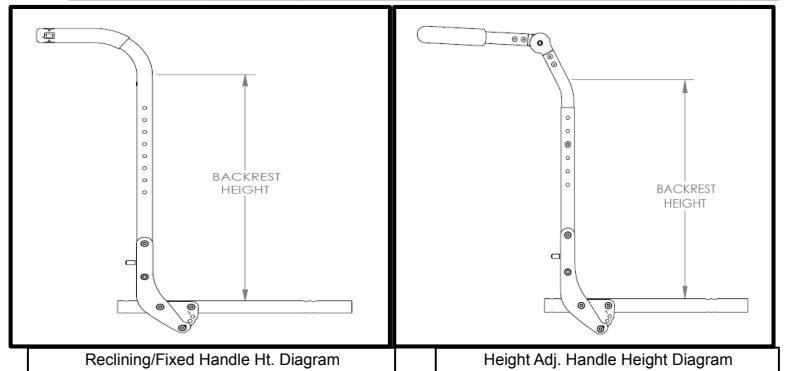

7. BACKREST / SEATING (CONT)

A. Backrest Position (set up by Quickie)

See **FIGURE 4** Dimension C. The location of the backrest surface in relation to the front of the backpost. The measurement is taken from the front surface of the backpost to the deepest area of the backrest in contact with the user's body.

<input type="checkbox"/>	194BQ01	+3"	NC
<input type="checkbox"/>	194BQ05	+2"	NC
<input type="checkbox"/>	194BQ02	+1"	NC
<input type="checkbox"/>	194BQ03	Flush	NC
<input type="checkbox"/>	194BQ04	-1"	NC
<input type="checkbox"/>	194BQ06	-2"	NC

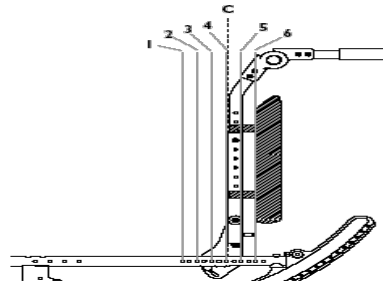

Figure 4

Back Type	
1	3" forward (+3")
2	2" forward (+2")
3	1" forward (+1")
4	Flush
5	1" rearward (-1")
6	2" rearward (-2")

8. ARMREST / SIDEGUARDS

Armrest

Armrests w/ Transfer Bar N/A w/ 14" Seat Depth			
<input type="checkbox"/>	194AA100	Dual Post Height Adj No Transfer Bar	\$336.00
<input type="checkbox"/>	194AA101	Dual Post Height Adj w/Transfer Bar	\$348.00
<input type="checkbox"/>	194AA102	Dual Post Flip Back Height Adj No Transfer Bar	\$312.00
<input type="checkbox"/>	194AA103	Dual Post Flip Back Height Adj w/Transfer Bar	\$326.00
<input type="checkbox"/>	194AA104	Single Post Height Adjustable - Std	\$326.00
<input type="checkbox"/>	194AA105	Single Post Height Adjustable - Low	\$326.00
<input type="checkbox"/>	194AA14	Omit Armrest	\$0.00

Armpad

<input type="checkbox"/>	194AM25	Desk	NC
<input type="checkbox"/>	194AM26	Full	NC

Armrest Receiver (Single Post Height Adjustable Only)

<input type="checkbox"/>	194AR17	Low	NC
<input type="checkbox"/>	194AR18	Std	NC

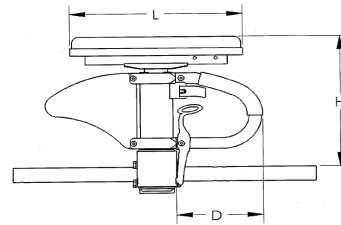

Armrest Matrix for Single Post

Armrest Size	Transfer Tube Length D	Receiver	H Range	Pad Length L	
				Desk	Full
STD	8"	STD	10 3/4" to 15 3/4"	10 1/4"	14"
		LOW	8 3/4" to 13 3/4"		
LOW	5 1/4"	STD	9" to 13"	10 1/4"	14"
		LOW	7 1/4" to 11 1/4"		

9. KEY OPTIONS AND ACCESSORIES

Anti Tips

<input type="checkbox"/>	194AT1	Anti Tips (Pair)	\$116.00
--------------------------	--------	------------------	----------

Positioning Belt

<input type="checkbox"/>	194A141	1.5" Auto Buckle Universal w/Clamp	\$94.00
<input type="checkbox"/>	194A118	2" Aircraft Buckle Pad w/Clamp	\$196.00
<input type="checkbox"/>	194A120	Positioning Belt Clamps Only	\$59.00

JAY Positioning

<input type="checkbox"/>	194K1	JAY Lower Extremity S/A support <input type="checkbox"/> Left <input type="checkbox"/> Right Position	\$307.00
<input type="checkbox"/>	194K2	Omit Hanger <input type="checkbox"/> Left <input type="checkbox"/> Right	-\$10.00
<input type="checkbox"/>	194K7	Pad Size <input type="checkbox"/> 6" x 8" <input type="checkbox"/> 8" x 10"	NC

Vent Tray

<input type="checkbox"/>	194LF13	Dovetail Vertical Frame Mounted Hardware for Trilogy Ventilators	\$501.00
<input type="checkbox"/>	194LF12	Dovetail Vertical Frame Mounted Hardware for LTV Ventilators	\$501.00

Misc.

<input type="checkbox"/>	194A1	Black Utility Backpack	\$107.00
<input type="checkbox"/>	194TS03	Tilt Stops	\$35.00
<input type="checkbox"/>	194A999	Quickie Water Bottle & Holder	\$78.00

Standard Frame Colors			
<input type="checkbox"/>	194C140	Aztec Gold	NC
<input type="checkbox"/>	194C2	Black <i>(Not avail as base w/Zebra)</i>	NC
<input type="checkbox"/>	194C141	Black Cherry	NC
<input type="checkbox"/>	194C10	Black Opal	NC
<input type="checkbox"/>	194C38	Blue Opal	NC
<input type="checkbox"/>	194C36	Candy Blue	NC
<input type="checkbox"/>	194C14	Candy Purple	NC
<input type="checkbox"/>	194C35	Candy Red	NC
<input type="checkbox"/>	194C142	Electric Blue	NC
<input type="checkbox"/>	194C143	Evergreen	NC
<input type="checkbox"/>	194C44	Glossy White	NC
<input type="checkbox"/>	194C126	Glow	NC
<input type="checkbox"/>	194C144	Green Apple	NC
<input type="checkbox"/>	194C147	Hot Sparkle Pink	NC
<input type="checkbox"/>	194C148	Mauve Pink	NC
<input type="checkbox"/>	194C103	Rootbeer	NC
<input type="checkbox"/>	194C114	Sparkle Silver	NC
<input type="checkbox"/>	194C145	Sunrise Orange	NC
<input type="checkbox"/>	194C113	Titanium Color Paint	NC
<input type="checkbox"/>	194C8	Yellow	NC

Matte Frame Colors			
<input type="checkbox"/>	194C116	Matte Black	NC
<input type="checkbox"/>	194C151	Matte Black Cherry	NC
<input type="checkbox"/>	194C150	Matte Electric Blue	NC
<input type="checkbox"/>	194C149	Matte Evergreen	NC
<input type="checkbox"/>	194C152	Matte Purple	NC

Personalized Frame Color			
<input type="checkbox"/>	194C112	Desert Camouflage	\$424.00
<input type="checkbox"/>	194C43	Mossy Oak Camouflage	\$424.00
<input type="checkbox"/>	194C42	Stars & Stripes	\$424.00
<input type="checkbox"/>	194C108	Zebra <i>(Choose above base color) Std with White unless above base paint is chosen N/A w/ Blk, Matte Black, Blk Opal, Titanium)</i>	\$424.00

Additional Options Through Built for Me

To inquire about any unique personalized Quickie products, contact: Phone: (800) 263-3390, Fax: (800) 561-5834



Sunrise Medical Canada Inc.
237 Romina Drive, Unit 3 • Concord, ON L4K 4V3 • Canada



JAY® Signature Series Backrest and Accessories
 Note: Not all sizes and configurations shown below, for full offering visit www.sunrisemedical.com
 When ordering mark the part number desired and it will be added to the order as a separate line item.

JAY BACKREST

JAY J3 Posterior (PA) BACK - 2.2" Contour Depth

	Shell Height	Shell Width															
Mid Thoracic (MT)	12.0" (S)	J3PAMTSxxFS	<input type="checkbox"/>	12	\$854	<input type="checkbox"/>	14	\$854	<input type="checkbox"/>	16	\$854	<input type="checkbox"/>	18	\$854	<input type="checkbox"/>	20	\$854
		J3PAMTSxxTH	<input type="checkbox"/>	12	\$854	<input type="checkbox"/>	14	\$854	<input type="checkbox"/>	16	\$854	<input type="checkbox"/>	18	\$854	<input type="checkbox"/>	20	\$854
Upper Thoracic (UT)	16.5" (S)	J3PAUTSxxFS	<input type="checkbox"/>	12	\$952	<input type="checkbox"/>	14	\$952	<input type="checkbox"/>	16	\$952	<input type="checkbox"/>	18	\$952	<input type="checkbox"/>	20	\$952
		J3PAUTSxxTH	<input type="checkbox"/>	12	\$952	<input type="checkbox"/>	14	\$952	<input type="checkbox"/>	16	\$952	<input type="checkbox"/>	18	\$952	<input type="checkbox"/>	20	\$952
	18.0" (M)	J3PAUTMxxFS	<input type="checkbox"/>	14	\$952	<input type="checkbox"/>	16	\$952	<input type="checkbox"/>	18	\$952	<input type="checkbox"/>	20	\$952	<input type="checkbox"/>	20	\$952
		J3PAUTMxxTH	<input type="checkbox"/>	14	\$952	<input type="checkbox"/>	16	\$952	<input type="checkbox"/>	18	\$952	<input type="checkbox"/>	20	\$952	<input type="checkbox"/>	20	\$952
19.5" (T)	J3PAUTTxxFS	<input type="checkbox"/>	14	\$952	<input type="checkbox"/>	16	\$952	<input type="checkbox"/>	18	\$952	<input type="checkbox"/>	20	\$952	<input type="checkbox"/>	20	\$952	
	J3PAUTTxxTH	<input type="checkbox"/>	14	\$952	<input type="checkbox"/>	16	\$952	<input type="checkbox"/>	18	\$952	<input type="checkbox"/>	20	\$952	<input type="checkbox"/>	20	\$952	
Shoulder Height (SH)	21.0" (S)	J3PASHSxxFS	<input type="checkbox"/>	14	\$981	<input type="checkbox"/>	16	\$981	<input type="checkbox"/>	18	\$981	<input type="checkbox"/>	20	\$981	<input type="checkbox"/>	20	\$981
		J3PASHSxxTH	<input type="checkbox"/>	14	\$981	<input type="checkbox"/>	16	\$981	<input type="checkbox"/>	18	\$981	<input type="checkbox"/>	20	\$981	<input type="checkbox"/>	20	\$981
	22.5" (M)	J3PASHMxxFS	<input type="checkbox"/>	16	\$981	<input type="checkbox"/>	18	\$981	<input type="checkbox"/>	20	\$981	<input type="checkbox"/>	20	\$981	<input type="checkbox"/>	20	\$981
		J3PASHMxxTH	<input type="checkbox"/>	16	\$981	<input type="checkbox"/>	18	\$981	<input type="checkbox"/>	20	\$981	<input type="checkbox"/>	20	\$981	<input type="checkbox"/>	20	\$981
24.0" (T)	J3PASHTxxFS	<input type="checkbox"/>	18	\$981	<input type="checkbox"/>	20	\$981	<input type="checkbox"/>	20	\$981	<input type="checkbox"/>	20	\$981	<input type="checkbox"/>	20	\$981	
	J3PASHTxxTH	<input type="checkbox"/>	18	\$981	<input type="checkbox"/>	20	\$981	<input type="checkbox"/>	20	\$981	<input type="checkbox"/>	20	\$981	<input type="checkbox"/>	20	\$981	

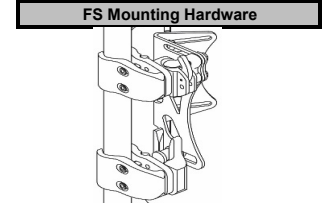

JAY J3 Posterior Lateral (PL) BACK - 3" Contour Depth

	Shell Height	Shell Width															
Mid Thoracic (MT)	15.0" (T)	J3PLMTTxxFS	<input type="checkbox"/>	12	\$941	<input type="checkbox"/>	14	\$941	<input type="checkbox"/>	16	\$941	<input type="checkbox"/>	18	\$941	<input type="checkbox"/>	20	\$941
		J3PLMTTxxTH	<input type="checkbox"/>	12	\$941	<input type="checkbox"/>	14	\$941	<input type="checkbox"/>	16	\$941	<input type="checkbox"/>	18	\$941	<input type="checkbox"/>	20	\$941
Upper Thoracic (UT)	16.5" (S)	J3PLUTSxxFS	<input type="checkbox"/>	12	\$1,021	<input type="checkbox"/>	14	\$1,021	<input type="checkbox"/>	16	\$1,021	<input type="checkbox"/>	18	\$1,021	<input type="checkbox"/>	20	\$1,021
		J3PLUTSxxTH	<input type="checkbox"/>	12	\$1,021	<input type="checkbox"/>	14	\$1,021	<input type="checkbox"/>	16	\$1,021	<input type="checkbox"/>	18	\$1,021	<input type="checkbox"/>	20	\$1,021
	18.0" (M)	J3PLUTMxxFS	<input type="checkbox"/>	14	\$1,021	<input type="checkbox"/>	16	\$1,021	<input type="checkbox"/>	18	\$1,021	<input type="checkbox"/>	20	\$1,021	<input type="checkbox"/>	20	\$1,021
		J3PLUTMxxTH	<input type="checkbox"/>	14	\$1,021	<input type="checkbox"/>	16	\$1,021	<input type="checkbox"/>	18	\$1,021	<input type="checkbox"/>	20	\$1,021	<input type="checkbox"/>	20	\$1,021
19.5" (T)	J3PLUTTxxFS	<input type="checkbox"/>	14	\$1,021	<input type="checkbox"/>	16	\$1,021	<input type="checkbox"/>	18	\$1,021	<input type="checkbox"/>	20	\$1,021	<input type="checkbox"/>	20	\$1,021	
	J3PLUTTxxTH	<input type="checkbox"/>	14	\$1,021	<input type="checkbox"/>	16	\$1,021	<input type="checkbox"/>	18	\$1,021	<input type="checkbox"/>	20	\$1,021	<input type="checkbox"/>	20	\$1,021	
Shoulder Height (SH)	21.0" (S)	J3PLSHSxxFS	<input type="checkbox"/>	14	\$1,050	<input type="checkbox"/>	16	\$1,050	<input type="checkbox"/>	18	\$1,050	<input type="checkbox"/>	20	\$1,050	<input type="checkbox"/>	20	\$1,050
		J3PLSHSxxTH	<input type="checkbox"/>	14	\$1,050	<input type="checkbox"/>	16	\$1,050	<input type="checkbox"/>	18	\$1,050	<input type="checkbox"/>	20	\$1,050	<input type="checkbox"/>	20	\$1,050
	22.5" (M)	J3PLSHMxxFS	<input type="checkbox"/>	16	\$1,050	<input type="checkbox"/>	18	\$1,050	<input type="checkbox"/>	20	\$1,050	<input type="checkbox"/>	20	\$1,050	<input type="checkbox"/>	20	\$1,050
		J3PLSHMxxTH	<input type="checkbox"/>	16	\$1,050	<input type="checkbox"/>	18	\$1,050	<input type="checkbox"/>	20	\$1,050	<input type="checkbox"/>	20	\$1,050	<input type="checkbox"/>	20	\$1,050
24.0" (T)	J3PLSHTxxFS	<input type="checkbox"/>	18	\$1,050	<input type="checkbox"/>	20	\$1,050	<input type="checkbox"/>	20	\$1,050	<input type="checkbox"/>	20	\$1,050	<input type="checkbox"/>	20	\$1,050	
	J3PLSHTxxTH	<input type="checkbox"/>	18	\$1,050	<input type="checkbox"/>	20	\$1,050	<input type="checkbox"/>	20	\$1,050	<input type="checkbox"/>	20	\$1,050	<input type="checkbox"/>	20	\$1,050	

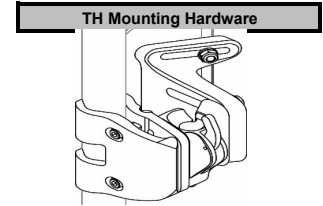

JAY J3 Posterior Deep (PD) BACK - 6" Contour Depth

Mid Thoracic (MT)	15.0" (T)	J3PDMTTxxFS	<input type="checkbox"/>	12	\$1,031	<input type="checkbox"/>	14	\$1,031	<input type="checkbox"/>	16	\$1,031	<input type="checkbox"/>	18	\$1,031	<input type="checkbox"/>	20	\$1,031
		J3PDMTTxxTH	<input type="checkbox"/>	12	\$1,031	<input type="checkbox"/>	14	\$1,031	<input type="checkbox"/>	16	\$1,031	<input type="checkbox"/>	18	\$1,031	<input type="checkbox"/>	20	\$1,031
Upper Thoracic (UT)	18.0" (M)	J3PDUTMxxFS	<input type="checkbox"/>	14	\$1,116	<input type="checkbox"/>	16	\$1,116	<input type="checkbox"/>	18	\$1,116	<input type="checkbox"/>	20	\$1,116	<input type="checkbox"/>	20	\$1,116
		J3PDUTMxxTH	<input type="checkbox"/>	14	\$1,116	<input type="checkbox"/>	16	\$1,116	<input type="checkbox"/>	18	\$1,116	<input type="checkbox"/>	20	\$1,116	<input type="checkbox"/>	20	\$1,116
Shoulder Height (SH)	21.0" (S)	J3PDSHSxxFS	<input type="checkbox"/>	14	\$854	<input type="checkbox"/>	16	\$854	<input type="checkbox"/>	18	\$854	<input type="checkbox"/>	20	\$854	<input type="checkbox"/>	20	\$854
		J3PDSHSxxTH	<input type="checkbox"/>	14	\$854	<input type="checkbox"/>	16	\$854	<input type="checkbox"/>	18	\$854	<input type="checkbox"/>	20	\$854	<input type="checkbox"/>	20	\$854

JAY J3 Back Whitmyer Headrest

AXYS Mount and Pad				LINX Mount and Pad			
<input type="checkbox"/>	J3HEDX8	AXYS Headrest with 8" Plush Pad	\$388.00	<input type="checkbox"/>	J3HEDL8	LINX Headrest with 8" Plush Pad	\$345.00
<input type="checkbox"/>	J3HEDX10	AXYS Headrest with 10" Plush Pad	\$388.00	<input type="checkbox"/>	J3HEDL10	LINX Headrest with 10" Plush Pad	\$345.00
<input type="checkbox"/>	J3HEDX14	AXYS Headrest with 14" Plush Pad	\$388.00	<input type="checkbox"/>	J3HEDL14	LINX Headrest with 14" Plush Pad	\$345.00
<input type="checkbox"/>	J3HEDXAAPN	AXYS with Adj-a-Plush Narrow Pad	\$530.00	<input type="checkbox"/>	J3HEDLAAPN	LINX with Adj-a-Plush Narrow Pad	\$487.00
<input type="checkbox"/>	J3HEDXAAPS	AXYS with Adj-a-Plush Std Pad	\$530.00	<input type="checkbox"/>	J3HEDLAAPS	LINX with Adj-a-Plush Std Pad	\$487.00

JAY J3 Back Laterals Swing Away Laterals With Pad - Pair

<input type="checkbox"/>	J3LAT4X4SA	SwingAway Lat with 4"x4" Pad (PR)	\$643.00	<input type="checkbox"/>	J3LAT6X4SA	SwingAway Lat with 6"x4" Pad (PR)	\$643.00
<input type="checkbox"/>	J3LAT4X5SA	SwingAway Lat with 4"x5" Pad (PR)	\$643.00	<input type="checkbox"/>	J3LAT6X5SA	SwingAway Lat with 6"x5" Pad (PR)	\$643.00
<input type="checkbox"/>	J3LAT4X6SA	SwingAway Lat with 4"x6" Pad (PR)	\$643.00	<input type="checkbox"/>	J3LAT6X6SA	SwingAway Lat with 6"x6" Pad (PR)	\$643.00



JAY® Signature Series Cushions

Note: Not all sizes and configurations shown below, for full offering visit www.sunrisemedical.com.
When ordering mark the part number desired and it will be added to the order as a separate line item .

JAY CUSHIONS

JAY Fusion Cushion			
<input type="checkbox"/>	JFUSION1416	JAY Fusion 14" x 16"	\$1,005.00
<input type="checkbox"/>	JFUSION1616	JAY Fusion 16" x 16"	\$1,005.00
<input type="checkbox"/>	JFUSION1618	JAY Fusion 16" x 18"	\$1,005.00
<input type="checkbox"/>	JFUSION1620	JAY Fusion 16" x 20"	\$1,005.00
<input type="checkbox"/>	JFUSION1717	JAY Fusion 17" x 17"	\$1,005.00
<input type="checkbox"/>	JFUSION1816	JAY Fusion 18" x 16"	\$1,005.00
<input type="checkbox"/>	JFUSION1818	JAY Fusion 18" x 18"	\$1,005.00
<input type="checkbox"/>	JFUSION1820	JAY Fusion 18" x 20"	\$1,005.00
<input type="checkbox"/>	JFUSION2018	JAY Fusion 20" x 18"	\$1,005.00
<input type="checkbox"/>	JFUSION2020	JAY Fusion 20" x 20"	\$1,005.00
<input type="checkbox"/>	JFUSION2220	JAY Fusion 22" x 20"	\$1,127.00

JAY Fusion Cushion w/ Single Valve Air Insert			
<input type="checkbox"/>	JFUSION1416AS	JAY Fusion 14" x 16"	\$1,005.00
<input type="checkbox"/>	JFUSION1616AS	JAY Fusion 16" x 16"	\$1,005.00
<input type="checkbox"/>	JFUSION1618AS	JAY Fusion 16" x 18"	\$1,005.00
<input type="checkbox"/>	JFUSION1620AS	JAY Fusion 16" x 20"	\$1,005.00
<input type="checkbox"/>	JFUSION1717AS	JAY Fusion 17" x 17"	\$1,005.00
<input type="checkbox"/>	JFUSION1816AS	JAY Fusion 18" x 16"	\$1,005.00
<input type="checkbox"/>	JFUSION1818AS	JAY Fusion 18" x 18"	\$1,005.00
<input type="checkbox"/>	JFUSION1820AS	JAY Fusion 18" x 20"	\$1,005.00
<input type="checkbox"/>	JFUSION2018AS	JAY Fusion 20" x 18"	\$1,005.00
<input type="checkbox"/>	JFUSION2020AS	JAY Fusion 20" x 20"	\$1,005.00
<input type="checkbox"/>	JFUSION2220AS	JAY Fusion 22" x 20"	\$1,127.00

JAY Fusion Cushion w/ Dual Valve Air Insert			
<input type="checkbox"/>	JFUSION1416AD	JAY Fusion 14" x 16"	\$1,021.00
<input type="checkbox"/>	JFUSION1616AD	JAY Fusion 16" x 16"	\$1,021.00
<input type="checkbox"/>	JFUSION1618AD	JAY Fusion 16" x 18"	\$1,021.00
<input type="checkbox"/>	JFUSION1620AD	JAY Fusion 16" x 20"	\$1,021.00
<input type="checkbox"/>	JFUSION1717AD	JAY Fusion 17" x 17"	\$1,021.00
<input type="checkbox"/>	JFUSION1816AD	JAY Fusion 18" x 16"	\$1,021.00
<input type="checkbox"/>	JFUSION1818AD	JAY Fusion 18" x 18"	\$1,021.00
<input type="checkbox"/>	JFUSION1820AD	JAY Fusion 18" x 20"	\$1,021.00
<input type="checkbox"/>	JFUSION2018AD	JAY Fusion 20" x 18"	\$1,021.00
<input type="checkbox"/>	JFUSION2020AD	JAY Fusion 20" x 20"	\$1,021.00
<input type="checkbox"/>	JFUSION2220AD	JAY Fusion 22" x 20"	\$1,144.00

JAY Union Cushion			
<input type="checkbox"/>	JU1416	JAY UNION 14" x 16"	\$735.00
<input type="checkbox"/>	JU1616	JAY UNION 16" x 16"	\$735.00
<input type="checkbox"/>	JU1618	JAY UNION 16" x 18"	\$735.00
<input type="checkbox"/>	JU1620	JAY UNION 16" x 20"	\$735.00
<input type="checkbox"/>	JU1717	JAY UNION 17" x 17"	\$735.00
<input type="checkbox"/>	JU1816	JAY UNION 18" x 16"	\$735.00
<input type="checkbox"/>	JU1818	JAY UNION 18" x 18"	\$735.00
<input type="checkbox"/>	JU1820	JAY UNION 18" x 20"	\$775.00
<input type="checkbox"/>	JU2018	JAY UNION 20" x 18"	\$775.00
<input type="checkbox"/>	JU2020	JAY UNION 20" x 20"	\$775.00
<input type="checkbox"/>	JU2220	JAY UNION 22" x 20"	\$775.00

JAY Union Reduced Profile Cushion			
<input type="checkbox"/>	JU1416RP	JAY Union RP 14" x 16"	\$735.00
<input type="checkbox"/>	JU1616RP	JAY Union RP 16" x 16"	\$735.00
<input type="checkbox"/>	JU1618RP	JAY Union RP 16" x 18"	\$735.00
<input type="checkbox"/>	JU1620RP	JAY Union RP 16" x 20"	\$735.00
<input type="checkbox"/>	JU1717RP	JAY Union RP 17" x 17"	\$735.00

JAY J2 Cushion			
<input type="checkbox"/>	2108-MJ	JAY J2 14" x 16"	\$800.00
<input type="checkbox"/>	2105-MJ	JAY J2 15.5" x 16"	\$800.00
<input type="checkbox"/>	2106-MJ	JAY J2 15.5" x 18"	\$800.00
<input type="checkbox"/>	2107-MJ	JAY J2 15.5" x 20"	\$921.00
<input type="checkbox"/>	2117-MJ	JAY J2 17" x 17"	\$800.00
<input type="checkbox"/>	2100-MJ	JAY J2 18" x 16"	\$800.00
<input type="checkbox"/>	2101	JAY J2 18" x 18"	\$800.00
<input type="checkbox"/>	2103-MJ	JAY J2 18" x 20"	\$921.00
<input type="checkbox"/>	2118-MJ	JAY J2 20" x 18"	\$904.00
<input type="checkbox"/>	2102-MJ	JAY J2 20" x 20"	\$1,069.00

JAY J2 Deep Contour Cushion			
<input type="checkbox"/>	2446	JAY J2 Deep Contour 14" x 16"	\$836.00
<input type="checkbox"/>	2466	JAY J2 Deep Contour 16" x 16"	\$836.00
<input type="checkbox"/>	2468	JAY J2 Deep Contour 16" x 18"	\$836.00
<input type="checkbox"/>	2460	JAY J2 Deep Contour 16" x 20"	\$908.00
<input type="checkbox"/>	2477	JAY J2 Deep Contour 17" x 17"	\$836.00
<input type="checkbox"/>	2486	JAY J2 Deep Contour 18" x 16"	\$836.00
<input type="checkbox"/>	2488	JAY J2 Deep Contour 18" x 18"	\$836.00
<input type="checkbox"/>	2480	JAY J2 Deep Contour 18" x 20"	\$908.00
<input type="checkbox"/>	2408	JAY J2 Deep Contour 20" x 18"	\$908.00
<input type="checkbox"/>	2400-MJ	JAY J2 Deep Contour 20" x 20"	\$1,051.00
<input type="checkbox"/>	2428	JAY J2 Deep Contour 22" x 18"	\$1,051.00

JAY X2 Cushion			
<input type="checkbox"/>	JX21416	JAY X2 14" x 16"	\$907.00
<input type="checkbox"/>	JX21616	JAY X2 16" x 16"	\$907.00
<input type="checkbox"/>	JX21618	JAY X2 16" x 18"	\$907.00
<input type="checkbox"/>	JX21620	JAY X2 16" x 20"	\$907.00
<input type="checkbox"/>	JX21717	JAY X2 17" x 17"	\$907.00
<input type="checkbox"/>	JX21816	JAY X2 18" x 16"	\$907.00
<input type="checkbox"/>	JX21818	JAY X2 18" x 18"	\$907.00
<input type="checkbox"/>	JX21820	JAY X2 18" x 20"	\$907.00
<input type="checkbox"/>	JX22020	JAY X2 20" x 20"	\$907.00

JAY Ion Cushion			
<input type="checkbox"/>	JION1416	JAY ION 14" x 16"	\$631.00
<input type="checkbox"/>	JION1616	JAY ION 16" x 16"	\$631.00
<input type="checkbox"/>	JION1618	JAY ION 16" x 18"	\$631.00
<input type="checkbox"/>	JION1620	JAY ION 16" x 20"	\$631.00
<input type="checkbox"/>	JION1717	JAY ION 17" x 17"	\$631.00
<input type="checkbox"/>	JION1816	JAY ION 18" x 16"	\$631.00
<input type="checkbox"/>	JION1818	JAY ION 18" x 18"	\$631.00
<input type="checkbox"/>	JION1820	JAY ION 18" x 20"	\$631.00
<input type="checkbox"/>	JION2018	JAY ION 20" x 18"	\$671.00
<input type="checkbox"/>	JION2020	JAY ION 20" x 20"	\$671.00
<input type="checkbox"/>	JION2220	JAY ION 22" x 20"	\$671.00

<input type="checkbox"/>	JU1816RP	JAY Union RP 18" x 16"	\$735.00
<input type="checkbox"/>	JU1818RP	JAY Union RP 18" x 18"	\$735.00
<input type="checkbox"/>	JU1820RP	JAY Union RP 18" x 20"	\$735.00
<input type="checkbox"/>	JU2018RP	JAY Union RP 20" x 18"	\$735.00
<input type="checkbox"/>	JU2020RP	JAY Union RP 20" x 20"	\$735.00